

Washington Oiled Sea Otter Response Handbook



Washington Department of Fish and Wildlife

July 2009

--This page intentionally left blank--

Table of Contents

Oiled Sea Otter Response Overview

Introduction and Background	1
Concept of Operation	1
Natural Resource Trustees for Sea Otters and Interested Governments	2
Organizational Structure and Unit Descriptions	3
The Marine Mammal Recovery and Transportation Unit	3
Sea Otter Capture Team	3
Carcass Recovery Team	4
Transport Team	4
Morgue	4
The Marine Mammal Rehabilitation Unit	4
Sea Otter Pre-Release Facility	5
Construction Team	5
Marine Mammal Hazing Unit	5
Training	5
Personnel Safety	6
Press Relations	6
Response Levels	6

Sea Otter Collection and Care Guidance

Overview and Genesis of Guidance	9
Reports and Documentation	9
Reconnaissance	10
Aerial Reconnaissance	10
Land Based Reconnaissance	11
Boat Reconnaissance	11
Capture	12
Land Based Capture	12
On Water Capture	13
Diver Capture	14
Transportation	14
Field Stabilization	15
Primary Treatment Facility	15
Intake	15
Wash	16
Drying	16
Post-wash Monitoring and Care	17
Nutritional Guidelines	17
Pre-Release Facility	18
Release	18
Carcass Management	19
Carcass Recovery Team	19

Appendices:

Appendix 1 – Potential Personnel Resources for Sea Otter Response	23
Appendix 2 – USFWS Capture Factors to Consider	27
Appendix 3 – Intake Procedures	29
Appendix 4 – Wash/Rinse Procedures	35
Appendix 5 – Formula and Hand Rearing Guidelines	37
Appendix 6 – Weight and Length Range	39
Appendix 7 – Oiled Marine Mammal Forms	41
Appendix 8 – Oiled Marine Mammal Evidence Collection Protocol	53
Appendix 9 – Marine Mammal Necropsy Report	55
Appendix 10 – Treatment Information and Orders	63
Appendix 11 – Marine Mammal Blood Results	65

Oiled Sea Otter Response Overview

Introduction and Background

The Northwest Wildlife Response Plan (Chapter 9970, II, A, iii) directs the USFWS and WDFW to develop appropriate response actions to effectively recover and care for oiled sea otters in the Northwest Area. It further directs the trustees to authorize individuals to collect, transport and rehabilitate oiled sea otters within the legal framework of the Marine Mammal Protection Act (16 USC 1379(h) and 1382(c)). This Handbook provides the organizational and specific operational guidance needed to conduct an oiled sea otter recovery and rehabilitation effort. It describes how oiled sea otters would be located and recovered on the outer coast of Washington State, how they would be transported to treatment facilities for rehabilitation and then re-acclimated for release back into the wild. This handbook is intended to provide guidance when dealing with oiled otters. The Wildlife Branch Director may make adjustments to this guidance based on situational circumstances and expert opinion.

In recent years, approximately 1,100 sea otters (*Enhydra lutris kenyoni*) were estimated to populate the outer coast of Washington. This growing population of sea otters is found along the coast from Point Grenville north to Neah Bay and is at risk from an oil spill affecting those waters. Unlike most marine mammals that possess a thick layer of insulating blubber sea otters are highly vulnerable to oil because they depend on their exquisitely maintained pelage (fur) for insulation. When sea otter fur becomes oiled there is an immediate loss of thermal protection.

Sea otters in Washington State are not listed under the Federal Endangered Species Act, but they are listed as Endangered on Washington's Species of Concern (SOC) List and they are protected by the Marine Mammal Protection Act.

I. Concept of Operation

Efforts to rescue sea otters injured during an oil spill must be performed as an integrated part of the overall oil spill response effort in accordance with the Northwest Area Contingency Plan (NWACP) and the Northwest Wildlife Response Plan, Section 9970. The Responsible Party (RP) is expected to initiate and fund sea otter rescue operations in accordance with the plan. In the event that there is not an identified RP the Wildlife Branch will request that the Unified Command authorize expenditures from the Oil Spill Liability Trust Fund (OSLTF) to implement the oiled sea otter response.

Oiled otters will be located and recovered by reconnaissance and capture teams working out of staging areas on the Olympic Coast. A separate transport team will transport captured animals as quickly as possible, preferably by air, to a primary treatment facility. Once there, the animals will be admitted, evaluated, stabilized, washed and then supported thru primary recovery. The animals will be cared for until they have their pelage reconditioned and vital health parameters restored. Once the animals are waterproof and in good condition and have passed a health screening approved by USFWS they will be transferred to a pre-release facility until USFWS determines when where and how they can be released.

Currently there is not a dedicated primary treatment facility for oiled otter rehabilitation in the Northwest. Consequently, this sea otter response plan relies on a combination of mobile facilities (specially equipped trailers and tents) and the voluntary assistance of participating public aquariums to care for and house otters.

II. Natural Resource Trustees for Sea Otters and Interested Governments

The USFWS is the lead federal trustee agency with responsibility for protection and management of sea otters, and WDFW is the state trustee with similar responsibilities. Initial notifications will be made to the natural resource trustee agencies by the OSC's in accordance with the Northwest Area Contingency Plan (Chapters 3000 and 9000). The Wildlife Branch Director can contact the following interested groups with follow up information and requests for assistance using the contact numbers below.

Agency and Tribal Contact Information

US Fish and Wildlife Service	(360) 971-6000
Wash. Dept. of Fish and Wildlife	(360) 534-8233
Makah Tribe	(360) 645-2201
Quileute Tribe	(360) 374-6163
Hoh Tribe	(360) 374-6582
Quinault Nation	(360) 276-8211
Olympic National Park	(360) 565-3000
Olympic Coast NMS	(360) 457-6622, x13
Wash. Maritime NWR Complex	(360) 457-8451

These groups may be notified by the Wildlife Branch but are not formal trustees:

<i>Point Defiance Zoo and Aquarium</i>	<i>(253)677-3386</i>
	<i>(206) 463-3149</i>
	<i>(253) 677-1543</i>
<i>Seattle Aquarium</i>	<i>(206) 604-0790</i>
<i>Vancouver BC Aquarium</i>	<i>(415) 847-2781</i>
<i>Marine Mammal Rescue Center Pager</i>	<i>(604) 735-4777</i>
<i>Oregon Coast Aquarium</i>	<i>(541) 867-3474 x5577</i>
<i>National Marine Fisheries Marine Mammal Stranding Network</i>	<i>(206) 526-6733</i>

III. Organizational Structure and Unit Descriptions

The Northwest Area Contingency Plan (NWACP) and the Wildlife Rescue Plan (Chapter 9970) describe the general organizational structure for wildlife response. This Handbook specifies the following additional functional units (shaded) specific to sea otter rescue. Duties and issues that relate to a specific position or team are listed in the sections that follow.

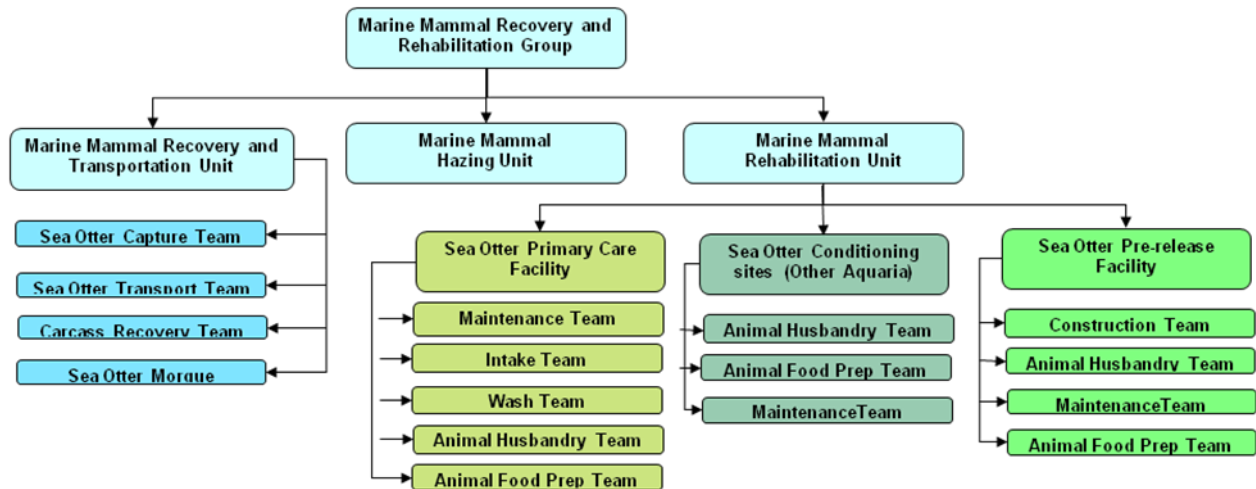

The Marine Mammal Recovery and Transportation Unit

The Marine Mammal Recovery and Transport Unit leader is responsible for recovering live and dead oiled sea otters and their transportation to appropriate facilities. The leader will be coordinating the response to reports of oiled sea otters coming from the Reconnaissance Unit, other spill response field teams and members of the public. Depending upon the size and complexity of the response the following teams and positions may be established. The teams will be managed by the Marine Mammal Recovery and Transport Unit leader who will consolidate the personnel and equipment needs and forward them to logistics via the Wildlife Branch Director. Dead otters will be collected by the Capture Team. However, if carcasses are so numerous that it impairs the ability of the Capture Team to recover living animals then the Marine Mammal Recovery and Transport Unit leader will deploy separate Carcass Recovery Teams.

Sea Otter Capture Team

The Sea Otter Capture Team is responsible for recovery of oiled sea otters (live and dead). The Capture Team leader is responsible for forming capture teams of appropriate personnel equipped to locate and capture oil injured sea otters. The Team Leader is responsible for directing, tracking and reporting results from all deployed capture teams. The leader will ensure that all team members receive a safety and assignment brief prior to daily operations and will request needed equipment and provisions through the Marine Mammal Recovery and Transportation Unit. The Capture Team leader will communicate with the Transport Team leader concerning estimated arrival times and locations for captured animals needing transport.

Carcass Recovery Team

The Carcass Recovery Team Leader is responsible for collecting dead sea otter carcasses. The Team Leader is responsible for forming carcass recovery teams of appropriate personnel and equipment to relocate and recover dead sea otters. Recovery operations will be fully documented with the location and condition of the recovered animal. Carcasses will be transferred via the Transport Team to the designated morgue. Chain-of-custody documentation will be maintained throughout the process.

Transport Team

The transport team is responsible for transporting live animals from the field to the treatment facility as well as carcasses to the morgue. The Transport Team leader is responsible for coordinating the capture and transportation teams and will notify the primary treatment facility as to when animals will be arriving. The Team Leader will ensure that all team members receive a safety and assignment brief prior to daily operations. The leader will request needed equipment and provisions through the Marine Mammal Recovery and Transportation Unit.

Morgue

The Morgue Supervisor is responsible for receiving, documenting and storing spill-related animal mortalities. The Morgue Supervisor will provide daily reports regarding the number of carcasses in custody at the morgue to the Marine Mammal Recovery and Transportation Unit Leader. The Supervisor will request needed equipment and provisions through the Marine Mammal Recovery and Transportation Unit leader.

The Marine Mammal Rehabilitation Unit

The Marine Mammal Rehabilitation Unit is responsible for the operation of the Primary Treatment Facility, Sea Otter Conditioning Sites and Pre-release Facility. The mission of the unit is to restore oiled sea otters to a healthy condition and prepare the animals for release into their natural habitat. The Unit will determine staff and equipment needs and submit appropriate requisition requests through the Wildlife Branch Director.

The Marine Mammal Rehabilitation Manager is responsible for setting up and operating the treatment and pre-release facilities, establishing safe and appropriate housing for the animals and facilitating animal husbandry activities. The manager coordinates the flow of animals from intake thru release. The manager will receive instructions either verbally during the early hours of the response and/or via an ICS-204 assignment form. The manager will ensure that all staff members receive a safety and assignment brief prior to daily operations.

Five Teams report directly to the Marine Mammal Rehabilitation Manager:

- Intake Team
- Wash Team
- Animal Husbandry Team
- Animal Food Prep Team
- Maintenance Team

The Intake Team conducts the initial examination, evaluation, documentation and tagging of the animal and provides treatment to stabilize the animal. The Wash Team anesthetizes, washes, rinses and dries the animal. The Animal Husbandry Team monitors and cares for the animals at either the Primary Treatment Facility, alternate sea otter conditioning sites or at the pre-release facility. The Animal Food Prep Team prepares and delivers food for the animals at either the Primary Treatment Facility, alternate sea otter conditioning sites or at the pre-release facility. The Maintenance Team is responsible for maintaining and repairing the Primary Treatment Facility, the Pre-release Facility and any associated equipment.

Sea Otter Pre-Release Facility

The mission of the Pre-Release Facility is to facilitate animal husbandry activities and provide safe and appropriate housing for the animals while they regain strength prior to release. The Pre-release Facility Manager reports to the Marine Mammal Rehabilitation Unit, and is responsible for construction and operation of the pre-release facility. The manager will receive his instructions either verbally during the early hours of the response and/or via an ICS-204 assignment form. The manager will ensure that all staff members receive a safety and assignment brief prior to daily operations. The manager will manage the construction and maintenance of the Pre-Release Facility. Depending on the logistics of the operation food may be prepared at the Primary-Treatment Facility and then transported to the Pre-release facility daily. The manager will request needed equipment and provisions through the Marine Mammal Rehabilitation Unit.

Construction Team

The Construction Team orders and assembles components of the pre-release facility including the floating net pens and necessary support structures such as a shed to house food prep and animal monitoring.

Marine Mammal Hazing Unit

Sea otters are generally considered difficult to haze because they dive and scatter when disturbed, but often return to the original location. Although, sensitive to noise and other disturbances no proven technique for herding otters out of an area is known. Activation of the Marine Mammal Hazing Unit for a sea otter response will be considered by the Wildlife Branch Director on a case by case basis.

IV. Training

When possible, personnel with experience working with sea otters should be used for tasks that involve contact with the animal. People with this experience include: sea otter researchers, appropriate aquaria staff and Federal, State or tribal resource managers. The number of people required to execute an oiled otter rescue and rehabilitation operation is large and it will severely tax the available pool of workers with experience with sea otters. Consequently, experienced workers will need to be placed strategically and used to supervise inexperienced personnel. For the larger responses it may be necessary to institute a formal introductory training program to prepare inexperienced personnel to deal with sea otters.

V. Personnel Safety

All personnel working on tasks where exposure to oil is likely must be current in Occupational Safety and Health Administration (OSHA) training and job specific safety training in accordance with the Northwest Wildlife Response Plan. Additionally, all workers must be provided a daily safety brief prior to beginning operations and they are required to conform to the Site Safety Plan and the incident specific Wildlife Branch Safety Plan for the response.

VI. Press Relations

All information that is to be released to the public must be done so via the Public Information Officer (PIO) and the Joint Information Center (JIC). There is a very high level of public interest in oil injured wildlife and sea otters in particular. The PIO in coordination with the WBD will facilitate appropriate interviews or photo opportunities for the press. Press teams arriving without prior approval should be directed to the PIO. If field teams encounter press teams they should advise them not to interfere in the field operations and they should not give interviews without the approval of the PIO. Crews members may identify themselves by name and explain the general nature of their work (i.e., we are capturing oiled sea otters or recovering dead sea otters) but should make no statements concerning impact or cause of the spill or answers any question that calls for speculation.

VII. Response Levels

The size of the spill and more importantly the number of sea otters affected will determine the numbers of staff that are needed to perform the functions identified above. The numbers of personnel needed for various levels of sea otter impacts are listed by function in Table 1. The levels are as follows:

Level I	more than 100 sea otters (Daily intake not to exceed 40 otters)
Level II	50 to 99 sea otters (Daily intake not to exceed 24 otters)
Level III	10 to 49 sea otters (Daily intake not to exceed 12 otters)
Level IV	1 to 9 sea otters (Daily intake not to exceed 6 otters)

Table 1 and 1a identify the estimated personnel and equipment that would be required to mount a response appropriate to the levels listed above. It is probable that an oil spill on the outer coast would impact both sea otters and marine birds. Consequently some positions may serve dual function for both birds and otters. These positions include the Wildlife Branch Director, Wildlife Veterinarian, the Wildlife Reconnaissance Group and associated equipment.

Table 1 Personnel Needs for Sea Otter Collection and Rehabilitation by Response Level				
Response Level	Level IV	Level III	Level II	Level I
	1 or 9	10 to 49	50 to 99	>=100
Personnel				
Wildlife Branch Director	1	1	1	1
Deputy Wildlife Branch Director	0	1	1	1 to 2
Wildlife Veterinarian	1	2	3	4
Marine Mammal Recovery & Rehabilitation Group Supervisor	0-1	1	1	1
Deputy Marine Mammal Recovery & Rehabilitation Group Supervisor	0	0	1	1
Marine Mammal Recovery and Transportation Unit Leader	1	1	1	1
Deputy Marine Mammal Recovery and Transportation Unit Leader			1	1
Sea Otter Capture Team Leader	1	2 to 4	4 to 8	10
Sea Otter Capture Team Staff	4	8 to 16	16 to 32	40
Sea Otter Transport Team Leader	1	1	2	2
Sea Otter Transport Team Staff	2 to 3	3 to 6	6 to 10	10
Mort Recovery Team Leader		1	1	1
Mort Recovery Team Staff		4	4	4
Morgue Supervisor	1	1	1	2
Marine Mammal Hazing Unit Leader	*	*	*	*
Deputy Marine Mammal Hazing Unit Leader	*	*	*	*
Marine Mammal Hazing Unit Staff	*	*	*	*
Marine Mammal Rehabilitation Unit Leader	0-1	1	1	1
Deputy Marine Mammal Rehabilitation Unit Leader		1	1	2
Sea Otter Primary Care Facility Manager	1	2	2	2
Maintenance Team	2 to 3	4	8	12
Intake Team (DVM + 2 animal handlers + recorder)	4			
Wash Team (Anesthesia + 3 to 5)	4 to 6	8 to 12	12 to 16	16 to 24
Animal Husbandry Team (DVM + 2handlers + 1 additional for every 6 more otters)	4	4 to 12	12 to 20	20 +
Animal Food Prep Team (15 lb of food per otter per day) L4 15-135 lb, L3 150-735 lb, L2 750-1485 lb, L1 >=1500	2 to 4	4 to 6	6 to 8	8 to 10
Sea Otter Conditioning Site Leader	0	1	1 to 2	2 to 3
Animal Husbandry Team	4	4 to 12	12 to 20	20 +
Animal Food Prep Team	2 to 4	4 to 6	6 to 8	8 to 10
Maintenance Team	2 to 3	4	8	12
Sea Otter Pre-release Facility Manager	1	1	1	1
Construction Team	4	8	12	12
Animal Husbandry Team (As needed similar numbers to those assigned to primary treatment facility)	4	4 to 12	12 to 20	20 +
Maintenance Team (Retained from construction team as needed)	4	8	12	12
Animal Food Prep Team	2 to 4	4 to 6	6 to 8	8 to 10
Volunteer Coordinator**	0-1	1	1 to 2	2 to 3
Wildlife Reconnaissance Group Supervisor**	0-1	1 to 2	2 to 3	2 to 3
Aerial Survey Unit Leader**	0-1	0-1	1	1
Aerial Survey Unit Staff**	1	1 to 2	2 to 4	5+
Boat Survey Unit Leader**	0-1	0-1	1	1
Boat Survey Unit Staff**	0-2	2+	5+	10+
Shoreline Survey Unit Leader**	0-1	0-1	1	1
Shoreline Survey Unit Staff**	3	6	8	15
* Hazing to be considered on a case by case basis for otters (staffing dependent on method selected).				
** May not need to duplicate staff likely in place for bird reconnaissance.				

Table 1a Equipment Needs for Sea Otter Collection and Rehabilitation by Response Level				
Response Level	Level IV	Level III	Level II	Level I
	1 or 9	10 to 49	50 to 99	>=100
EQUIPMENT				
Capture and Transport Equipment				
Dip Net	1	2 to 4	4 to 8	10+
Bite pillow	2	4 to 8	8 to 16	20+
Herding boards	3	6 to 12	6 to 9	10+
restraint box	1	2 to 4	4 to 8	10+
Vehicle - Recovery (pick-up or cargo van)	2	4 to 8	8 to 16	20+
Vehicle - Transport	2 to 3	2 to 3	2 to 3	3+
Coolers of ice	1	2 to 4	4 to 8	10+
Boat - Capture	1	2 to 4	4 to 8	10+
ATVs (if approved for use)	1	2 to 4	4 to 8	10+
Helicopter on call for land/water recovery	0-1	0-1	1 to 2	1 to 2
Fixed wing aircraft on call for otter transport	0-1	0-1	1 to 2	1 to 2
Sky kennels for capture and transport	6	12	24	24+
Field Stabilization Facility (optional)	0-1	0-1	1	1
Treatment Equipment				
Holding cages (for drying critical care monitoring) 4 per wash station	4	8 to 16	20 to 32	40+
Temp controlled holding area (approximate)	10x10	10x100	50x100	50x100 +
Wash Rinse Dry Station - Permanent or temporary (i.e. 53 foot response trailer)	1	1 to 2	3 to 4	5 to 7
Post Wash Holding (2 otter pens) or suitable segregated available space in non-display tanks	1 to 5	5 to 16	17 to 27	27 plus
Freshwater maximum daily consumption (wash and holding in 2-otter cages)	39600	122400	208800	225600
Post waterproofing holding pools (Circular 14 ft diameter 4 foot deep) hold 6 compatible animals	2	9	9 to 15	16+
Saltwater daily maximum consumption (gallons)	441600	1987200	3312000	3753600
Towels for drying otters (per day)	60	120	240	250
Pet Dryers (one per cage)	4	8 to 16	20 to 32	40+
Food preparation capacity per day in pounds	135	150 to 735	750 to 1485	1500+
Vehicle to pick up food supplies	1 car	1 pick-up	1 pick-up	1 van
Sea Otter Conditioning sites	1	1 to 2	2 to 4	4
Pre-Release Facility Equipment				
Pre release Pen (10x18 net pen plus floats) 8 otters each with pad for special grouping i.e. mother with pups	1 to 2	6 to 8	12 to 14	14+
Staff Support facility (Building or boat to shelter and support sea otter monitoring and care staff)	1	1	1	1
Food preparation facility (Not needed if food prepared at Primary Care Facility and shipped daily)	1	1	1	1
Boats	1 to 2	1 to 2	1 to 2	1 to 2
Transport Cages (Probably the same ones used for collection)	6	12	24	24+

Sea Otter Collection and Care Guidance

Overview and Genesis of Guidance

In the event of an oil spill that is likely to impact Washington's coastal population of sea otters The Northwest Area Contingency Plan and the Wildlife Response Plan will be activated. This Handbook summarizes and documents oiled sea otter capture and rehabilitation protocols that should be used in Washington State. As stated earlier, the Wildlife Branch Director may make adjustments to this guidance based on situational circumstances and expert opinion.

Various sources were used to develop the document. Following the March 24, 1989 Exxon Valdez oil spill, efforts were made to rehabilitate as many of the 357 recovered oil-impacted sea otters as possible. This effort resulted in a significant accumulation of experience much of which was published by Williams and Davis in their seminal 1995 publication "Emergency Care and Rehabilitation of Oiled Sea Otters. More recently efforts by the BC/States Oil Spill Task Force, the California Office of Spill Prevention and Response (OSPR) and NOAA have identified protocols for the collection, treatment and eventual release of oil-injured sea otters. Lessons learned from these efforts have been incorporated into this document. In particular a large part of the protocols that were originally produced for OSPR by the Oiled Wildlife Care Network (OWCN) have been adopted, modified, and included in this document.

Special thanks to those who helped prepare and review this section: Mike Ziccardi (Oiled Wildlife Care Network, Dave Jessup,(California Office of Spill Prevention and Response), John Rupp, Karen Goodrowe and Lisa Triggs, (Point Defiance Zoo and Aquarium), Martin Hulena (Vancouver BC Aquarium), Jim Burke, and Judy Tuttle (Oregon Coast Aquarium), C.J. Casson, Traci Belting and Shawn Larson (Seattle Aquarium), Deanna Lynch and Cindy Schexnider (United States Fish and Wildlife Service) , Ed Bolby (Olympic Coast Marine Sanctuary) Steve Jeffries, Barry Troutman, Andy Carlson and Don Noviello (Washington State Department of Fish and Wildlife).

Reports and Documentation

The following records will be prepared as described in the appropriate sections to follow. Copies can be found in the indicated appendices of this document. Records will ultimately be retained by the USFWS. When possible team leaders and unit managers should retain a copy of all filled out forms. Search effort logs and position reports originals are to be forwarded via the Documentation Unit to the Wildlife Branch Director. The live and dead animal data logs should be kept with the animals until treatment is complete. Copies are to be forwarded via the

Documentation Unit to the Wildlife Branch Director whenever the animal is transferred between locations or units.

1. Oiled Marine Mammal Search Effort Log	Appendix 7
2. Oiled Marine Mammal Position Report	Appendix 7
3. Oiled Marine Mammal Data Log: Live Animals	Appendix 7
4. Oiled Marine Mammal Data Log: Dead Animals	Appendix 7
5. Oiled Marine Mammal Intake Form	Appendix 7
6. Oiled Marine Mammal Daily Progress Form	Appendix 7
7. Marine Mammal Necropsy Report	Appendix 9
8. Treatment Information and Orders Form	Appendix 10
9. Marine Mammal Blood Result	Appendix 11

Reconnaissance

In the event of a spill, or potential spill, near areas inhabited by sea otters the Wildlife Branch conducts aerial, land, and water reconnaissance to determine the threat to sea otters. It is critical that at least one person on every reconnaissance team be familiar with locating and observing sea otters. Personnel from USFWS, WDFW, Olympic Coast National Marine Sanctuary (OCNMS) and other otter research groups should be contacted. Consult Appendix 1, Tables 1 and 2 for a list of potential aerial and shore side reconnaissance personnel. Information gathered will be used to respond in a manner appropriate to the situation. Details of all search efforts (aerial, land or boat based) and location of live and dead animals encountered must be recorded on an Oiled Marine Mammal Search Effort Log and Oiled Marine Mammal Position Report (Appendix 7). This information must be communicated back to the Situation Unit, Environmental Unit and Wildlife Branch via the Wildlife Reconnaissance Group leader by the quickest means possible (radio, satellite phone, cell phone, landline).

Aerial reconnaissance flights specifically designed to locate and assess concentrations of otters in the oil spill trajectory area will be requested from the Marine Mammal Reconnaissance Group. These flights are best conducted using fixed wing aircraft and trained sea otter observers to overfly known sea otter concentration areas to further investigate oil impacts on otters in these areas. Much of the staff for Wildlife Reconnaissance Group may also serve for reconnaissance of birds and other wildlife but at least one observer trained in aerial reconnaissance of sea otters must be included on these flights. Flights should operate at an altitude high enough to minimize disturbance of sea otters (usually at least 800 feet and greater altitudes will be necessary for noisier aircraft). Requests for air assets must be coordinated through the Air Ops unit in Planning as per the Incident Command Structure defined in the NWACP. Results of all reconnaissance flights including the area covered, viewing conditions, the position of observed sea otters and the proximity of these animals to oil must be communicated back to the Situation Unit, Environmental Unit and Wildlife Branch via the Wildlife Reconnaissance Group leader by the quickest means possible (radio, satellite phone, cell phone, landline). Teams should be provided with GPS capability (either handheld with external antenna or aircraft-mounted), marine VHF radio, maps or chart copies of sufficient detail to mark precise locations of otter sightings, binoculars, digital camera with lens focal length between 100mm and 200mm, and a logbook for recording sightings of sea otters or other marine mammals, and appropriate flight

safety equipment as determined by the Safety Officer in consultation with the Air Operations Unit.

Land based reconnaissance teams will consist of at least two people equipped with: binoculars, spotting scope, digital camera, GPS, VHF radio, topographic maps, satellite phone and/or cell phone, documentation forms and supplies, Rite-in-the-Rain field notebook, Oiled Marine Mammal Search Effort Logs and Oiled Marine Mammal Position Reports (Appendix 7), surveyor's flagging tape, suitable body (evidence) tags, flashlight, water, first aid kit, daypack, personal protective equipment, ATV (only for appropriate approved sites), and emergency survival gear. Teams will be given specific assignments to search specific locations. Sites where sea otters are located can be flagged with colored tape to assist the capture team in locating sites where otters have been observed. The date, color, and position of the flagging should be noted and the flagging itself should be labeled with the date of the observation to separate old observations from later ones. Dead animals should also be photographed, tagged, and then collected or secured above the high tide line if possible. Personnel that encounter oil during their reconnaissance efforts must complete appropriate decontamination prior to returning to non-oiled locations.

Boat reconnaissance teams may be utilized. These teams may be able to reach remote areas faster and investigate offshore rocks and islands more completely. Boat operators must have experience in operating small craft along Washington's outer coast, especially in near shore areas around rocks, islands and kelp beds. These teams will consist of at least two people equipped with: binoculars, spotting scope, digital camera, GPS, marine VHF radio, nautical charts, satellite phone and/or cell phone, documentation forms and supplies, Rite-in-the-Rain field notebook, Oiled Marine Mammal Search Effort Logs and Oiled Marine Mammal Position Reports (Appendix 7), surveyor's flagging tape, suitable body (evidence) tags, flash light, water, first aid kit, daypack, personal protective equipment, and emergency survival gear. Teams will be given specific assignments to search specific sections of the coastline from the water. Dead animals found in the water must be collected and shall be photographed, tagged, and the recovery location (latitude and longitude) recorded. Shallow draft, maneuverable and very seaworthy watercraft is needed to conduct this type of patrol. It is highly desirable to have boat operators with local boating experience and a detailed knowledge of the coastline. The outer coast of Washington is often rugged with numerous offshore rocks, both exposed and submerged, and is frequented by hazardous weather conditions including: fog, high winds, high seas, heavy rain and or snow, which may limit the potential to conduct search operations.

Teams will be deployed in accordance with the following conditions:

- Boats will not be used for searches if small craft warning conditions are in effect. Teams will not be deployed in fog or extreme wind or surf conditions or if small craft warnings are forecast that could prevent safe recovery of the teams.
- Since adverse conditions cannot always be anticipated, teams will have an emergency egress plan before deployment to areas dependent on aircraft or boats for recovery. Boats should be equipped with GPS and utilize the track back feature to retrace their steps through safe water in the event of a sudden deterioration in visibility.
- Teams will have a communication plan/schedule and will test primary communication prior to departure of the aircraft or boat inserting the team.

- Personnel and vessels that encounter oil during reconnaissance efforts must complete appropriate decontamination prior to returning to non-oiled locations.

Capture

The outer coast of Washington is frequented by hazardous weather conditions including: fog, high winds, high seas, heavy rain and or snow, which may limit the potential to conduct rescue operations. Capture of sea otters requires specific approval from USFWS prior to otter rescue operations and teams must receive clearance from the safety officer prior to deployment. Deployment assignments are based on the current reconnaissance information. All captured animals must be tagged with a Passive Integrated Transponder (PIT) tag and documented. The transport cage should also be labeled with the PIT tag number.

Active otters are difficult to capture and resources may be limited. Consequently, capture efforts will need to be prioritized. Factors that may influence capture prioritization:

- The number of animals oiled. Capture priority may be based on gender where females are targeted to maximize the potential for population rebuilding,
- The efficiency with which animals can be caught. Concentrations of oiled animals in more easily accessible locations may be given priority over isolated animals in extremely difficult to access locations,
- Impaired animals. Animals that are already beached and may be easier to catch might be prioritized over healthy active animals, and
- Capture method. Most sea otters will be recovered with dip-nets either on shore or on the water's surface. Using divers to capture sea otters is difficult to conduct in open water and is reserved for favorable conditions. Gill net or tangle net use is considered inappropriate for capture of sea otters in Washington and if pursued would require specific case-by-case approval.

See Appendix 2 for additional capture related factors based on the USFWS Washington Sea Otter Rescue Protocols of 1994.

Land Based Capture: Land based capture crews consist of multiple team members and may include a vehicle driver, catch coordinator/net person, animal handler, and safety spotter. Teams may consist of personnel from USFWS, WDFW, NOAA (OCNMS), specialized wildlife handling organizations (OWCN), or others trained in sea otter capture, and will be led by personnel experienced in sea otter capture. A list of potential sea otter recovery personnel can be found in Appendix 1, Table 3. These teams may have to access remote beaches by boat, helicopter or, in some cases, appropriate off road vehicles.

Teams will be equipped with: large dip nets (possibly equipped with a drawstring opening), capture boxes, transport cages, bite pillows, herding boards, communication gear (radio), appropriate PPE for handling otters (i.e. eye protection, heavy leather gloves), cotton towels, cooler with ice, GPS, camera, data forms, water, food, ropes and or hoist sling, suitable otter tags, emergency shelter, and first aid kit.

Technique: Once an oiled sea otter is spotted on land, the first task is to prevent it from fleeing into the water. In general, capture will be accomplished using nets (e.g., long-handled hoop nets, throw nets) and/or herding boards rather than by hand (Fowler, 1995; Geraci and Lounsbury,

1993). Sea otter handlers should not attempt to hold an otter by their fur/skin because it is very loosely attached and a sea otter can turn very easily within its fur to bite the handler. In the case of neonates (newborns) or animals that are unconscious or in a position that makes manual capture and restraint safer than using rigid equipment, exceptions are made. (Extracted from *OWCN Protocols for the Care of Oil-Affected Marine Mammals 2005 page 8*)

On Water Capture: On the water capture of sea otter may be conducted with a large (34") diameter dip net with a seven foot handle. This requires a small boat and a crew of at least three: a net person, animal handler and boat operator. As described by Benze and Britton (in Williams and Davis, 1995). On water capture teams also require a larger offshore vessel to help with safety, logistics, and possibly to facilitate air lifting oiled otters.

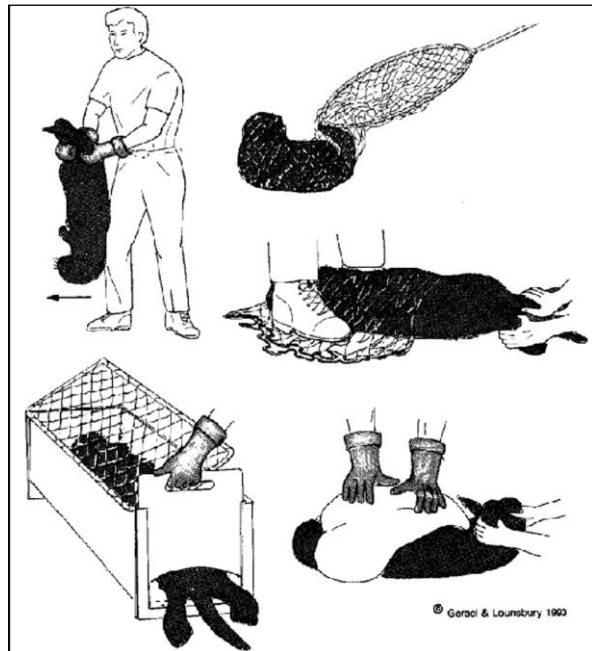

Figure 2. Sea Otter handling techniques

Technique: The person holding the dip net crouches in the bow of the boat and holds onto a bow rope. The skiff operator approaches the sea otter at high speed and then throttles back as the person scoops the animal into the net. The netted otter is held against the side of the boat at the surface of the water until the skiff operator or an assistant can help bring the animal into the boat. During the capture, the sea otter may become aware of the boat's approach and attempt to escape. Otters that assume a defensive, pawing posture or swim away by backing up on the water's surface are the easiest to capture.

The most dangerous stage of the process is getting the animal from the net into the cage as their power and flexibility may allow them to bite or escape. Sea otter handlers should not attempt to hold an otter by their fur/skin because it is very loosely attached and a sea otter can turn very easily within its fur to bite the handler. All personnel will wear appropriate PPE including safety goggles, protective clothing, and nitrile gloves (or nitrile gloves inside leather gloves). It is best to work in teams of two when transferring the animal to a transport cage (see Fig. 2 for illustrations). For larger animals, more than one handler may be required. Transfer can be accomplished by orienting the transfer cage door up with the door open and then inverting the dip net into the cage. A bite pillow can be used to keep the animal sealed in the cage until the door can be closed. Physical restraint devices such as squeeze cages, otter restraint boxes and stuff bags may be needed for sea otters (Geraci and Lounsbury, 1993, Williams and Sawyer, 1995). Additional animals should be collected only if they can be taken within approximately an hour of the first capture and the vessel has space and cages for additional animals, otherwise, animals are delivered to the transport unit immediately. Caged otters can be transported by boat to a suitable drop off location or hoisted and transported by a helicopter directly to a coastal airport or treatment facility.

Diver Capture: Otters may be captured by diver operated Wilson traps (Geraci and Lounsbury, 1993; Benz and Britton, 1995). This involves locating otters that are resting at the surface, most often in kelp, and then deploying a dive team (see Fig. 3). The dive team positions itself below the otter using re-breather (bubble-less) dive gear and a self propelled Wilson trap vehicle. The team then brings the trap to the surface around the otter and closes a drawstring to capture the animal. These operations are very dangerous for both the animal and the capture team, and will only be undertaken by experienced personnel with appropriate training.

Transportation

Once a live sea otter has been captured it must be delivered as soon as possible to the Transport Unit. The transportation unit will most likely be staged at a local airport or helicopter base with staff deployed to boat ramps, docks, beaches, roads or trail heads near capture team operations. See Appendix 1, Table 4 for a list of potential sea otter Transport Unit personnel.

Technique: Transport teams are made up of a team leader who coordinates schedules and one or more team members to deliver the animals to the aircraft and/or treatment center. If at all possible an animal technician/veterinary technician will be assigned to monitor the animal in transit for signs of hyperthermia or hypothermia and make adjustments to regulate temperature. Cool animals should be warmed while insuring adequate ventilation, while overheated animals should be given ice.

Animals to be transported should be housed in transport carriers such as Sky[®] or Vari-kennels[®]. Dimensions should approximate 32" x 22" x 23" or 36" x 24 x 26 and the kennel should have modified and elevated floors to minimize damage to the fur due to defecation during transit. The floor grate that comes with the kennel should be modified by adding spacers made of 2 inch PVC pipe cut in 1 inch sections between the floor and the grate to ensure that urine and fecal material falls away from the animal. The grate should be attached to the floor with cable ties so the animal can't pull the grate up during transport (this is extremely important). There should be a hole in the bottom of the kennel so that everything drains into a water-proof tray for removal. During transport the door should be cable tied shut so that it can't be opened by the animal. If the animal begins to chew on the wire of the door or other parts of the kennel the animal should be offered some type of enrichment (i.e., ice or Tygon tube) to keep it busy. While in route the animal should be protected from wind exposure and stimulation kept to a minimum.

Because rapid delivery is essential it will generally not be possible to group large numbers of animals together for air transport, thus, flights for individual animals or small groups will be most likely. Fixed wing aircraft or helicopters can be contracted for transport, but provisions must be made to maintain the animal at approximately 65 degrees with adequate ventilation. Sea otters are suspected of being susceptible to injury from high altitude flights due to decreased atmospheric pressure and lower oxygen partial pressure, thus flights should be flown at a safe elevation between 1000 and a maximum of 5000 feet. Unattended travel may be necessary but sending an animal handler is preferred and highly recommended to monitor thermal condition

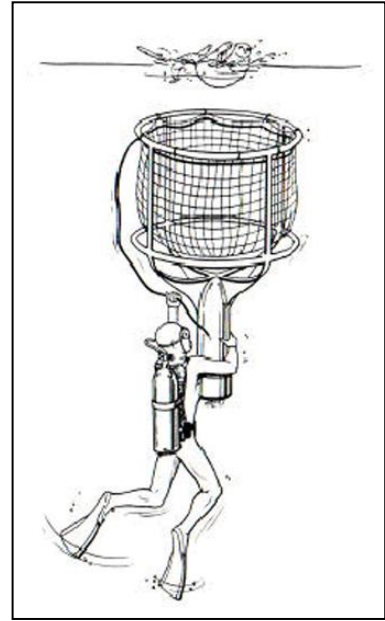

Figure 3. Wilson Trap

and make adjustment as necessary. Flights can be arranged out of Quillayute Prairie Airfield, Sekiu Airfield, Forks Airfield or potentially by seaplane out of Neah Bay or La Push. Oiled otters that are treated at the Point Defiance Zoo and Aquarium would most likely be delivered by air to Tacoma Narrows Airport and then by van to the aquarium. The Newport Airport would serve animals being flown to the Oregon Coast Aquarium.

Specific requests for flights will be directed to Air Operations. Flights must be carefully coordinated to minimize delay at both ends. Plans to land helicopters on the beach must be coordinated through the Environmental Unit (EU) to ensure that the choice of landing site or flight path does not pose a risk to other wildlife resources. Pick up at the receiving airport and van transfer to the primary treatment facility must be coordinated to avoid delays in treatment. If transport is delayed more than four hours, the transport unit should begin field stabilization.

Field Stabilization

Field stabilization is necessary when it will be more than four hours until the animal reaches the rehabilitation facility. This may involve assessing the animal for hypothermia or hyperthermia and treating accordingly; administering oral electrolyte solution and subcutaneous fluids, removing large amounts of oil from the eyes and nares, and administering emergency medications under the guidance of a veterinarian. *This section was derived from Chapter 2 of the OWCN Protocols, page 12.*

Primary Treatment Facility

Since there is not a facility in the Northwest capable of accepting and processing large numbers of oiled sea otters, treatment of otters relies heavily on participating zoo and aquarium facilities augmented with equipment, personnel and funding at the time of a response. The number of animals effected and space available at the aquariums will likely contribute to the decision on which facilities are selected as a Primary Treatment Facility. Since the speed of initial treatment can have a significant impact on overall rehabilitation success the Point Defiance Zoo and Aquarium is likely the best candidate. The Oregon Coast Aquarium has a much greater amount of available space for housing otters but it is located farther from the Washington sea otter population. Utilizing the Oregon Coast Aquarium as a conditioning site to house and care for washed otters could be most beneficial.

Intake, holding, wash/rinse, and waterproofing are the primary activities that occur within the primary treatment facility. Otters are examined at intake to assess their physical health and condition so as to receive proper treatment. Once they have been examined and are found to be healthy enough to withstand the wash/rinse process the oil is washed from their fur. Their fur is then dried and they put into specialized cages that have haul outs and access to a pool. Once their fur has regained its insulating qualities they are moved to larger pools and then eventually to pre-release sites just prior to being released back into the wild. The following discussion describes the processes that occur within the primary treatment facility. *The majority of this section is based on work done by the Oiled Wildlife Care Network in California.*

Intake: Once the animals arrive at the primary treatment facility they will be processed through intake. They will be evaluated by a DVM and their condition classified into one of the following categories in accordance with the criteria described by Williams and Davis (1995):

- Urgent: Heavily oiled otters contaminated by fresh oil (toxic aromatic vapor likely to be present) or displaying hypoglycemic shock and or hypothermia.
- Immediate: Moderately oiled animals or heavily oiled animals contaminated by weathered oil (likely to have little remaining toxic aromatics) and showing few medical abnormalities. Also animals showing moderate respiratory distress, mild hypoglycemia, or hypothermia.
- Delayed: Moderately oiled animals contaminated by weathered oil (likely to have little remaining toxic aromatics) and showing no clinical or behavioral sign of distress or lightly oiled or un-oiled otters with minor clinical signs (periodic agitation or shivering, etc).
- Minimal: Lightly oiled and un-oiled otters showing no clinical signs of distress.
- Expectant: Animals suffering severe subcutaneous emphysema as determined by palpation and displaying diaphragmatic or agonal (shallow, slow, irregular) breathing.

Animals will be given treatment including washing, thermal stabilization, hydration and nutritional augmentation based on the order of the categories listed above. Delayed and Minimal animals will be held if Urgent or Immediate are on site awaiting treatment. Expectant animals will be considered for euthanasia. Appendix 3 summaries intake procedures based on procedures developed by the Oiled Wildlife Care Network.

Wash: To facilitate the washing of the animals WDFW's 53 foot oiled wildlife rescue semi-trailer may be deployed to the primary care facility if the facility does not have washing capability. The trailer is equipped with an onboard water heating system, air heating, ventilation, air conditioning systems, wash stations with temperature controlled faucets as well as limited space for lab work. The trailer is designed to be powered by a portable generator and can be parked outside where there is access to freshwater. Using the trailer will help isolate oiled animals and associated oily wastewater from the aquarium's water system. When possible the municipal sewer system will be used for waste water discharge. If not possible, portable storage tanks (baker tanks) will collect wash water and transport it to an appropriate treatment facility. Appendix 4 summaries wash/rinse procedures based on procedures developed by the Oiled Wildlife Care Network.

Drying: Otters are initially hand dried with dry, clean, cotton terry cloth towels. Once the bulk of the water has been absorbed, the fur is dried with commercial pet dryers that deliver high volume, temperature controlled air (Davis and Hunter et al., 1995). Sea otters become increasingly prone to hyperthermia as their hair is drying and cool (room temperature) air may be necessary for drying as the sea otter's body temperature increases. Following drying, each animal will be reversed from the anesthetic and placed in a large, slat-floor kennel with a sliding top or other easily accessible dry pen for intensive care monitoring. Animals in dry holding should be closely monitored for hyperthermia and fecal, urine, or food debris must be rinsed away immediately. When fully recovered from anesthesia, otters should be offered small blocks of ice to chew on and food (Davis and Hunter, 1995).

Once the animal is stable and medical conditions allow, each otter will be moved to one of the "two-otter pen-pools" (one pool, two haul-outs) which will be serviced by abundant, clean, chlorine-free soft (2-5 grain hardness) 65 degree F fresh water (Work by Dr. Jessup indicates that using fresh 65-degree soft (2-5 grain hardness) water in the pools reduces recovery time to three

to five days. Pools must have high water flow rates (e.g. five gallons per minute for 150 gallon pool) and drain skimmers at water level to collect debris from the pool. WDFW currently has two of these pens. Fecal and food contamination of the pool water can cause fur fouling and prevent restoration of water repellency. Sea otters are not waterproof after washing and drying and must reintroduce trapped air into their fur by grooming.

Post-wash monitoring and care: During rehabilitation, sea otters need to be monitored around-the-clock by qualified personnel familiar with normal sea otter behavior and who are able to recognize clinical signs of distress. Sea otters often develop hypothermia once returned to pen-pool due to lack of air insulation in washed fur and inadequate grooming. Otters that appear hypothermic, are having difficulty hauling out, or are experiencing seizures should be immediately removed from the water and evaluated by a veterinarian. As health and fur condition improve, otters may be moved to larger pools and/or floating holding pens. All pools should have abundant haul-out space. It will generally take a minimum of seven to ten days for the fur to recover its water repellency (Tuomi et al., 1995).

Common problems encountered while washing animals:

- Oil is not coming off with Dawn: Pretreatment with canola oil, olive oil, or methyl oleate is required.
- The animal's coat is not clean: The animal may not have been washed or rinsed adequately. In either case, the animal may need to be re-washed or re-rinsed.
- The wash or rinse water is too hard and mineral deposits are forming on the fur: Water hardness should be rechecked to make sure it is 3-5 grains.
- The holding pool is not clean: Check whether the water is turbid or if there is fish oil or debris floating on the pool surface. Water flow may need to be increased or pool cleaned

Nutritional Guidelines: Sea otters possess a very high metabolic rate and require a higher food intake than similarly sized mammals. The dietary requirements of stranded sea otters are generally grouped into two categories according to age and nutritional needs: un-weaned pups and weaned animals. Nursing pups need special dietary formulas and feeding regimes (see Appendix 5 for guidelines) while free-feeding animals are generally fed a diet of good quality shellfish such as clams and crab. Unlike some other populations the Washington coastal sea otter population relies almost exclusively on shellfish and not fish, thus herring and other baitfish are not an optimal choice. Sea otters also usually receive a supplemental multivitamin, vitamin E, and salt tablets (if housed *for extended periods* in fresh water) with amounts based on species and weight. Sea otters will generally avoid vitamins hidden in food. It is common practice to make a frozen slurry with medicines and vitamins mixed in (Casson, CJ 1990 Administering Oral Medications to Captive Sea Otters, Proceedings: International Trainers Association, Nov 4-8, Chicago, Illinois, p. 12-14). Monitoring fecal production and hydration status is especially important when beginning any formula, switching diets, or weaning animals. . The goal in rehabilitating oiled sea otters is their return to the wild; consequently all reasonable effort should be made to present food in a manner that does not increase the chance that the otters will associate food with humans. More information can be obtained on sea otter nutrition and energetics from Worthy (2001) and the AZA Sea Otter Standards and Guidelines, and Hand-rearing and Artificial Milk Formulas from Williams and Davis (1995) for sea otters.

Pre-release Facility

Once waterproof, sea otters will be housed in larger salt-water tanks and provided with a suitable haul out. The otters will be monitored until they have been cleared by USFWS for delivery to a pre-release facility. A pre-release facility is essentially a floating pen with haul out areas that is moored in a location near the eventual release site. On-site staff feed the animals and monitor their condition. Survival of released sea otters is enhanced by placing them in a pre-release facility where they can regain strength and re-acclimate to life in the wild.

Due to the potential for adverse weather it is not feasible to position pre-release pens directly on the exposed outer coast. The pre-release facility will most likely be located on the Washington Coast in La Push, Neah Bay and possibly Grays Harbor or Port Angeles. These locations offer sheltered waters suitable for the anchoring of the pens and infrastructure to support the maintenance of the facility and animals. Selection of the site will need to consider the location where animals were initially captured, potential for re-oiling, and the suitability of the area for release of animals. In some cases animals may have to be held for extended periods at a location remote for the spill site because ongoing cleanup operation prevent reintroduction of animals at this site. Personnel from the Aquaria, the Washington State Department of Fish and Wildlife and the California Oiled Wildlife Care Network, contractors and appropriate volunteers would augment the staff for cleaning and support of the animals. Appendix 1, Table 5 has a list of potential sea otter Treatment Unit personnel.

Pens suitable for the housing otters can be constructed in accordance with designs found in Williams and Davis 1995 (see page 170-173). Components are available from:

EZ Dock Ontario
221 Courtright Line
Brigden ON, Canada
NONIBO 1-800-654-8168
<http://www.ezdockontario.com/>

Jet Dock Systems, Inc.
9601 Corporate Circle
Cleveland, Ohio 44125
1-800-538-3625
<http://www.jetdock.com/index.asp>

Treatment and monitoring the health of washed otters takes a minimum of one to two weeks. The pre-release facility can be constructed during this time provided the components, equipment, funds and staff are available and direction is provided early in the process. The primary components should be assembled and tested during periodic field exercises as they are somewhat difficult to put together.

In addition to the pens, it is necessary to compile supporting resources. Staff equipped with shore side facilities to procure and prepare appropriate food, a suitable workboat to deliver staff to the pens, and supplies must be available. A minimum of four people are needed; a supervisor (preferably a DVM) and three shift workers to prepare food and observe the animal on a 24-hr basis. The staff must also order necessary supplies and keep records of the animals. A list of potential sea otter Pre-release Facility personnel can be found in Appendix 1, Table 6.

Release

This section is based largely on the OWCN Protocols for the Care of Oil-Affected Marine Mammals 5-07 (page 41). Animals completing rehabilitation need to be fully recovered prior to release into the wild. While little is known about optimal sea otter release criteria, current

criteria are based on information from the Exxon Valdez spill and husbandry practices at aquaria and rehabilitation centers in the United States. As more research is conducted, these criteria will likely change. Draft release criteria for sea otters are included on the NOAA National Marine Fisheries Service website: www.nmfs.noaa.gov/prot_res/PR2/Health_and_Stranding_Response_Program

General Release Criteria:

- Behavior
- Body Weight
- Pelage Condition
- Physical Exam
- Blood Parameters

Current criteria require that animals show normal behavior (feeding, swimming, and diving), adequate body weight for age class and species (Appendix 6), pelage proven to be in good condition, hematological and serum chemistry values within the normal range, no evidence of infectious diseases, and physical exam findings should be unremarkable. Other ancillary tests (e.g. leptospira titer, morbillivirus titer, toxoplasma titer, microbiological cultures, urinalysis, fecal examinations, etc.) may also be performed on a per-case basis depending on individual animal and population level concerns. The Unified Command will decide upon the location of the release with guidance from the USFWS along with the OCNMS, NMFS, WDFW and NPS. Note: An exit photo visually documenting the condition of each sea otter must be taken just prior to release for Natural Resource Damage Assessment purposes.

Carcass Management

The Marine Mammal Recovery and Transportation Unit is responsible for the management and oversight of carcass collection and storage. The Unit leader will work with Trustee agencies to establish a collection and documentation strategy that ensures the carcasses are treated as evidence and that the appropriate chain of custody protocols are followed.

All otter carcasses encountered in the field, as well as animals that die in captivity, will be collected, documented, and stored in a morgue managed by the Marine Mammal Recovery and Transportation Unit.

Carcass Recovery Team: Staffing for the Carcass Recovery Team may come from, government agencies, local tribes, response contractors and appropriate volunteers. A minimum of two people per team are needed to conduct carcass recovery operations: a carcass handler, and someone to address documentation, communications, and safety. If a boat is used a dedicated boat handler is required.

Technique: (modified from Chapter 7 OWCN Protocol 5-07, page 42) Dead oiled sea otters must be recovered and documented. Recovery of the animal carcass may reduce the environmental damage that could be caused when other animals scavenged on the oiled carcass. The carcass should be marked with a water resistant tag indicating the following information: species, date collected, time collected, location of collection, latitude, longitude, tag number, first initial and last name of collector.

The carcass should be photographed with the tag visible in the photograph and then the carcass bagged and placed in a cooler with ice. The disposition of sea otter carcasses will be directed by the USFWS. The USFWS may request that carcasses be sent directly to the National Wildlife

Health Center in Madison, Wisconsin or to the forensics lab in Ashland, Oregon. In some cases the necropsy may be conducted locally. Carcasses must be sampled for oil contamination and both the samples and carcass need to follow chain-of-custody procedures. If the animals are not being sent directly to a lab a local morgue will be established and staffed with a supervisor and staff who report to the Marine Mammal Recovery and Transportation Unit.

Dead animals will be logged into the morgue using the Oiled Dead Marine Mammal Data Log. Animals that die or are euthanized in captivity must have this information recorded on their individual record as well as in the Live Marine Mammal Data Log before the carcass is logged into the morgue. All carcasses should be identified with a written tag including the species, date of stranding and/or admission, date of death, and the flipper tag (if a tag was affixed prior to death). Carcasses received must be sampled for external oil prior to bagging in a plastic bag and the samples must be linked to the carcass with appropriate labeling. If a flipper tag is present, it should remain with the carcass.

The carcass should be refrigerated or kept on ice until a necropsy is performed. If a necropsy cannot be performed within 72 hours of death, the carcass should be frozen. Prior to performing a necropsy on an oiled sea otter, specific permission must be obtained from USFWS. In many cases, a pathologist with specialized training on sea otters will be asked to perform the necropsy. If a necropsy is performed all tissues must be saved unless directed to do otherwise by the wildlife veterinarian. All tissue samples collected must be cut into widths less than 1cm in thickness and placed in a small plastic or glass jar with 10% buffered formalin and labeled with the species name, field identification number, case number, and date the samples were taken. Jars should be placed into a larger empty plastic jar or Zip lock bag to prevent accidental leakage during shipping. (*Extracted from OWCN Protocols for the Care of Oil-Affected Marine Mammals 2005 page 38*).

Appendices

--This page intentionally left blank--

Appendix 1. Potential Personnel Resources for Sea Otter Response

Personnel listed here (see Tables 1-5) have qualifications and or experience that could make them useful for conducting oiled sea otter recovery and rehabilitation operations. These personnel could be made available at the discretion of their parent organization based on work load and spill response funding considerations. There is no obligation to participate. In most cases key individuals at participating organizations are identified that could either participate themselves and/or delegate other qualified personnel from their organization as current operations allow.

--This page intentionally left blank--

Table 1. Potential Aerial Sea Otter Reconnaissance Personnel						
Last Name	First Name	Phone WK	Cell	Emergency	E-mail	Organization
Jeffries	Steve	253.589.7235	253.219.4359	253.472.9439	JEFFRSJJ@dfw.wa.gov	WDFW
Jameson	Ron	541.754.4388		541.929.4781	ronaldjam@comcast.net	
Bowlby	Ed	360.457.6622			Ed.Bowlby@noaa.gov	Olympic Coast National Marine Sanctuary
Troutman	Barry	360.902.8121		360.357.2860	TROUTBLT@dfw.wa.gov	WDFW
Gearin	Pat	206.526.4034		206.745.6935		NMFS/NMML
Huber	Harriet	206.526.6433				NMFS/NMML
Calambokidis	John	360.943.7235		360.352.5320		Cascadia Research

Need: 1 or 2 per flight

Table 2. Potential Shoreside or Small Boat Sea Otter Reconnaissance Personnel						
Last Name	First Name	Phone WK	Cell	Emergency	E-mail	Organization
Jeffries	Steve	253.589.7235	253.380.4963	253.472.9439		WDFW
Casson	C.J.	206.386.4372	206.604.0790		ci.casson@seattle.gov	Seattle Aquarium
Bowlby	Ed	360.457.6622				Olympic Coast National Marine Sanctuary
Nicol	Linda	250.729.8374			Linda.Nichol@dfo-mpo.gc.ca	Pacific Biological Station, Nanaimo
Gill	Verena	907.786.3584	907.250.3721		Verena_gill@fws.gov	USFWS Anchorage
Bodkin	Jim	907.786.3550			jbodkin@usgs.gov	USGS
Coletti	Heather					USGS
Monson	Dan					USGS
Esslinger	George					USGS
Brancato	Mary-Sue					Olympic Coast National Marine Sanctuary

Need: up to 10 people to cover shoreside survey sites and 2 per reconnaissance boat

Table 3. Potential Sea Otter Recovery Personnel						
Last Name	First Name	Phone WK	Cell	Emergency	E-mail	Organization
Jeffries	Steve	253.589.7235	253.380.4963	253.472.9439		WDFW
Casson	C.J.	206.386.4372	206.604.0790		ci.casson@seattle.gov	Seattle Aquarium
Bowlby	Ed	360.457.6622				Olympic Coast National Marine Sanctuary
Nicol	Linda	250.729.8374			Linda.Nichol@dfo-mpo.gc.ca	Pacific Biological Station, Nanaimo
Gill	Verena	907.786.3584	907.250.3721		Verena_gill@fws.gov	USFWS Anchorage
Bodkin	Jim	907.786.3550			jbodkin@usgs.gov	USGS
Coletti	Heather					USGS
Monson	Dan					USGS
Esslinger	George					USGS
Brancato	Mary-Sue					Olympic Coast National Marine Sanctuary

Need: 4 or more members for each team deployed

Table 4. Potential Sea Otter Transport Unit Personnel						
Last Name	First Name	Phone WK	Cell	Emergency	E-mail	Organization
Lambourn	Dyanna	253.589.7235	253.208.2427	253.166.3931	Lambodml@dfw.wa.gov	WDFW MM Stranding Network

Need: 4 people including - team leader, two drivers and an animal monitor

Table 5. Potential Sea Otter Treatment Unit Personnel						
Last Name	First Name	Phone WK	Cell	Emergency	E-mail	Organization
Casson	C.J.	206.386.4372	206.604.0790		ci.casson@seattle.gov	Seattle Aquarium
Rupp	John	253.404.3675		253.591.5337	Jrupp@pdza.org	Point Defiance Zoo and Aquarium
Lambourn	Dyanna	253.589.7235	253.208.2427	253.166.3931	Lambodml@dfw.wa.gov	WDFW MM Stranding Network
Jessup	Dave				djessup@OSPR.DFG.CA	Ca-OSPR
Haulena	Martin	604.659.3468	604.831.9550		Martin.Haulena@vanaqua.com	Vancouver Aquarium
DeGhetto	Darlene	206.526.2863	206.854.8273			PAWS
Huckabee	John	425.787.2500	x814		jhuckabee@paws.org	PAWS
Burke	Jim	541.867.3474	x5423		jim.burke@aquarium.org	Oregon Coast Aquarium

Need: 14 to 16 people (minimum)

Table 6. Potential Sea Otter Pre-release Personnel						
Last Name	First Name	Phone WK	Cell	Emergency	E-mail	Organization

Need: 5 people to construct and maintain facility and at least another 4 for monitoring and feeding of animals

--This page intentionally left blank--

Appendix 2. Additional factors to consider when selecting otters to capture based on the USFWS Washington Sea Otter Rescue Protocols, 1994

Sea otters have many complicated behaviors associated with grooming, feeding, and mating. Common behaviors include rolling, somersaulting, repeated shallow diving, blowing bubbles, and intensive rubbing and working of the fur with the mouth, forepaws and hind flippers. These behaviors may be inappropriately interpreted as indicators of stress by inexperienced observers. Healthy sea otter fur can be recognized by the characteristic “beading” or rapid “wicking away” of water when the animal is on the surface.

Sea otters in the water should be considered for capture if the animal leaves a rainbow sheen, has an obvious smell of oil or the fur retains a slick, wet appearance even after the animal has been on the surface for extended periods of time. Other signs of possible oiling include loss of buoyancy, frequent head shaking (like a dog shakes its head after a swim), obvious shivering, tolerance of close approach by a boat, lethargy, or obvious emaciation. However, none of the above is a certain indicator that the animal is in fact oiled. For example, healthy young animals and adult males often will tolerate close approach by boats. If a sea otter keeps its distance from an approaching boat and appears alert to the presence of the boat, it is probably in relatively good condition and should not be pursued.

Sea otter pups frequently vocalize. And their high-pitches calls are easily mistaken for signals of distress. A mother-pup pair should never be pursued simply because the pup is vocalizing frequently. Newborn pups may move relatively little, and may be mistakenly categorized as lethargic or dead by inexperienced observers. The fur on pups often is lighter in color than adult fur. Natural clean fur on pups may resemble the chocolate-brown color of weathered oil. In addition, it is common for mothers and pups to become temporarily separated while the mother dives for food. In such cases, the pup often vocalizes frequently. Thus, apparently abandoned pups should be watched from a distance for 15-20 minutes before any decision is made to attempt capture. Mother-pup pairs should be approached by boat with the intent to capture only if there is clear evidence of oiling or severe distress (such as shivering or obviously matted fur).

Sea otters in Washington seldom haul out on sand beaches, thus any animals observed ashore on these types of beaches may be considered as distressed and therefore candidates for capture. However healthy Washington otters will occasionally haul out on rocky offshore reefs for short periods of time so this behavior should not necessarily warrant capture.

--This page intentionally left blank--

Appendix 3 Intake Procedures

Chapter 4 of the OWCN Protocols for the Care of Oil-Affected Marine Mammals is reproduced below and modified for Washington use. California specific references and issues have been removed; see the OWCN document for citations.

While completing the intake procedures, it is important to perform a thorough evaluation, collect all samples and data, be safe, and minimize the animal handling time. All personnel performing intake procedures should wear appropriate PPE including safety goggles, protective clothing, and nitrile gloves (or nitrile gloves inside leather gloves). It is best to work in teams of two (handler, examiner) or three (handler, examiner, recorder) in order to perform the intake in an efficient manner. For larger animals, more than one handler may be required. Physical restraint devices such as squeeze cages, otter restraint boxes (Figure 4) and stuff bags may be needed for larger pinnipeds and sea otters (Geraci and Lounsbury, 1993; Williams and Sawyer, 1995). Some animals (e.g., sea otters) may require chemical restraint for safe handling and examination (Williams and Sawyer, 1995; Haulena and Heath, 2001). Have all equipment and supplies needed for the intake procedure (and potential emergency treatment) ready and available before beginning the examination.

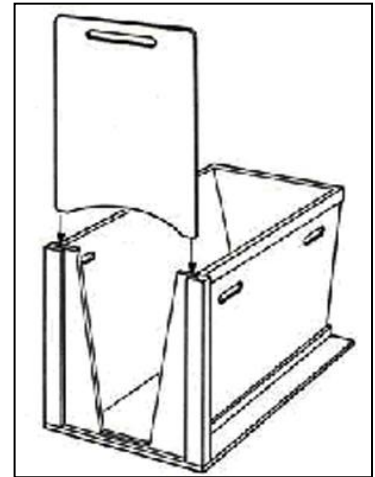

Figure 4. Otter restraint box.

Several different forms must be completed for every animal captured during an oil spill. The animal must first be logged into the **Oiled Marine Mammal Data Log** (Appendix 7) and the form must be completed. In addition, the **Oiled Marine Mammal Intake Form** (Appendix 7) must be completed for each animal. This form contains important questions about the extent of oiling, location and depth of oiling, as well as a place for documenting physical examination findings.

A brief physical examination will be made upon admission of each individual oiled animal (see below). A veterinarian or animal care specialist should conduct the examination and treat any conditions that are considered to be life threatening. The capture, transport, and intake process is extremely stressful and an oiled animal's condition may be very unstable. The intake area should be as dark and quiet as is practical and animals must be monitored closely during the examination and intake process. If an animal's condition deteriorates and a veterinarian is not participating in the examination, seek veterinary advice immediately.

Intake Procedure:

1. Intake Forms
2. Physical Examination
3. Flipper tag and microchip application
4. Oil sample collection

5. Photograph

The age class (pup, yearling, subadult, adult) and sex should be determined. Consult charts on age estimation sea otters (Appendix 6) and marine mammal guides such as Geraci and Lounsbury (1993), Reeves et al., (1992) and Ainley et al., (1980) for sex identification. All animals should be tagged or marked for individual identification. This can be done with plastic livestock ear tags (e.g., Rototag, Temptag Sea otters) should be identified using a commercially available pet microchip inserted subcutaneously at the inguinal region if not already done by the Capture Team.

For legal purposes, it is necessary to collect an oil sample from each individual animal. A detailed protocol for the collection of evidence is provided in Appendix 10. Briefly, visible oil should be scraped from the fur with a wooden spatula and placed into a chemically cleaned glass jar. For animals with no visible oiling, an affected area is rubbed with a 4x4 piece of fiberglass cloth with forceps or hemostats that have been cleaned with alcohol. Precautions must be taken to collect the sample without allowing nitrile gloves to touch the oil sample or the cloth it is collected on. The oil sample should be placed in a glass container and labeled appropriately with the following information: the oil spill name, date, species, intake log number of that animal, animal capture location, and flipper tag color and number and then sealed with evidence tape.

It is also necessary to take a digital photograph of the oiled animal. The photograph should include the entire animal, highlighting the oiled region, and if possible, show the flipper tag numbers. The photograph should be labeled with the same information as the oil sample; the oil spill name, date, species, intake log number of that animal, animal capture location, and flipper tag color and number. The photograph and oil sample are both pieces of evidence and should be securely stored until the Wildlife Branch Director provides further instructions. If samples are to be sent for analysis, a completed Chain of Custody form is required and should be provided by the laboratory.

Oil Sample & Photograph Label:

1. Oil spill name
2. Date
3. Species
4. Log number
5. Capture location
6. Tag color & number

Intake Forms:

- Live Mammal Data Log
- Oiled Marine Mammal Intake Form
- Treatment Information and Orders
- Marine Mammal Blood Results

Detection of Petroleum Products with Field Assay: Many sea otters have dark pelts with a natural sheen, often making it difficult to determine whether an animal has been exposed to petroleum products. With low-level exposure or extended periods since oiling, it can also become very difficult to clinically diagnose oil exposure in fur. In order to objectively diagnose oil exposure and prevent the stressful rehabilitation of non-exposed animals, the use of field diagnostic tests for the detection of petroleum products on marine wildlife have been evaluated (Mazet et al., 1997; Fritcher et al., 2002). The EnviroGard PAH immunoassay (Strategic Diagnostics, Newark, DE, USA) was found to be the most practical for use during an oil spill

response because of its portability, ease of use, cost (\$20 per sample), and ability to adequately discriminate between oiled and non-oiled samples. Results can also be obtained within a clinically relevant time (nine samples tested within one hour). During an oil spill, the use of a field assay may be instituted to quickly identify oil exposure in captured animals in order to allow quick release or relocation of non-exposed animals.

Samples for the immunoassay are collected by swabbing an animal in a circular three-inch diameter area just anterior to the tail head (just forward of the base of the tail on the animals back) for 15 seconds with a 4x4 in. rayon/polyester general-use gauze saturated with methanol. The gauze is placed into an extraction container and the manufacturer's directions are then followed carefully in order to complete the test. In animals testing positive with the field assay, additional samples may need to be taken for petroleum characterization and fingerprinting to be performed by a Petroleum Chemistry Laboratory.

Physical Examination: Animals are to be weighed and measured (standard length and axillary girth, xiphoid girth in sea otters) and the temperature measured with standard thermometer. If available a temperature sensing PIT tag can be applied and temperatures taken with a remote reader (Dave Jessup personnel comm.). Normal core temperature for sea otters is 99.5-100.6 °F (37.5-38.1 °C). If the use of a thermometer is not possible, feel the flippers (e.g., icy cold or dry and hot) and observe the animal's behavior (e.g., shivering, agitation) in order to evaluate abnormally high or low body temperature (Figure 5). If an animal is dry and alert/active prior to the exam, assume it will overheat with handling.

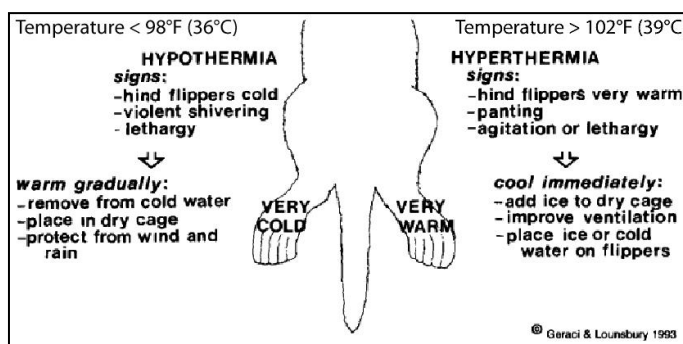

Figure 5. Signs and treatment of hypothermia and hyperthermia.

A complete whole body examination should be conducted, making note of the degree and nature of oil contamination. Assess behavior, activity level and alertness; if possible, observe the animal in the transport cage prior to handling to evaluate locomotion and central nervous system status. Evaluate overall body condition and estimate the percent dehydration. Most stranded animals are at least slightly dehydrated (<5%, demonstrated by decreased tear production and subdued behavior). More severely dehydrated animals (5-10%, demonstrated by lack of tear production, thick ocular mucus, "sunken" or crusty eyes, dry mucous membranes, skin tenting in otariids, and lethargic or depressed behavior) may need to be treated with fluids prior to continuing the examination and intake procedures; however, it is preferable to obtain blood samples prior to hydration treatments.

Due to the risk of being bitten, a thorough oral exam is possible only in anesthetized, dead, comatose, and young animals, but a visual inspection of the oral cavity is often possible during vocalization in alert animals. Palpate the neck and thorax for evidence of subcutaneous emphysema and the musculoskeletal system for fractures, wounds, or swellings. Subcutaneous emphysema is often found in the neck and axillary area in oiled sea otters and is an indicator of severe pulmonary damage. Palpate the abdomen gently to detect masses, pregnancy, or fluid

accumulation and observe the urogenital area for urine, feces, or abnormal discharges.

Routine Blood Sampling: Following the general examination, blood samples should be drawn for hematology (collected in an EDTA anticoagulant, lavender-top tube, LTT) and chemistry panels (collected in a serum separator tube, SST, or red-top tube, RTT) and serum banking. In sea otters, blood may be drawn from the popliteal (saphenous) or femoral vein on a non-anesthetized animal using a restraint box and/or stuff bag (see Fig. 6). Alternatively, the jugular vein can be used on an anesthetized sea otter.

Blood samples should be collected at least three times during the rehabilitation process: on admission/intake, immediately prior to washing, and prior to release. At these times, baseline blood work should include a complete blood count and standard serum chemistry tests. A form for documenting serial blood results is provided in Appendix 13. Normal blood values for marine mammal species can be found in Bossart, et al. (2001).

Standard Blood Tests: Complete Blood Cell counts (CBC): White cell blood count, red cell blood count, hemoglobin, hematocrit, mean corpuscular volume (MCV), mean corpuscular hemoglobin concentration (MCHC), mean corpuscular hemoglobin (MCH), a differential cell count, platelet and reticulocyte counts. One full lavender-top tube (EDTA) (1 or 3 ml) should be taken and refrigerated until analysis.

Chemistry Profile: Albumin, alkaline phosphatase, bicarbonate, bilirubin (total and direct), BUN, calcium, chloride, cholesterol, CK, creatinine, globulin, glucose, phosphorus, potassium, total protein, sodium, AST (SGOT), ALT (SGPT), GGT, and ratios of albumin:globulin, BUN:creatinine, and the sodium:potassium ratio. Blood should be placed in a serum separator tube or red top tube, allowed to clot, centrifuged, and refrigerated prior to sending for analysis. Excess

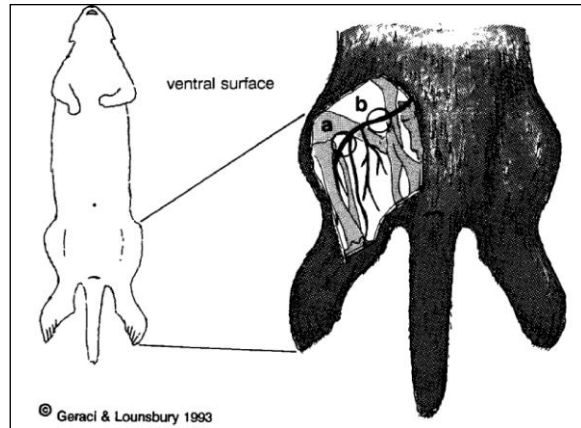

Figure 6. Femoral vein landmarks.

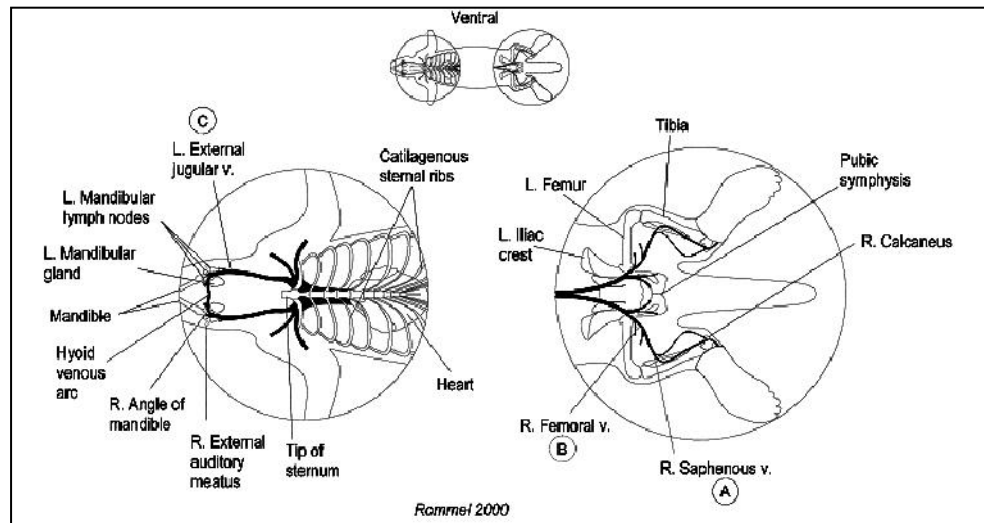

Figure 7. Sea otter blood collection sites (veins): A. Popliteal /Saphenous, B. Femoral , C. Jugular.

serum should be saved and banked (frozen) at the rehabilitation facility.

Special Biomedical Sampling Protocols: At times, additional protocols may be required by USFWS for additional blood samples for other tests (e.g., PAH estimation, immune function assays, serum protein electrophoresis, plasma chemistries, serological tests for infectious diseases). Other biomedical samples (e.g., urine sample, fecal sample, microbiological swab, blubber biopsy) may also be collected at the discretion of USFWS or the wildlife veterinarian.

Post-examination Intake Procedures:

Fluid therapy: oral, subcutaneous, intravenous.

Activated charcoal (ToxiBan) tubing if oil ingestion suspected.

All animals are assumed to be at least 5% dehydrated. Administer isotonic fluids to animals that appear to have not ingested oil orally at a rate of 10-20 ml/kg once either orally (e.g., Pedialyte) or subcutaneously (lactated Ringer's solution, LRS). If the animal is alert and is likely to have ingested oil (e.g., during grooming, neonates during nursing), administer activated charcoal (ToxiBan, 6 ml/kg) orally. When administering oral fluids, pre-measure the length of stomach tube needed by noting the distance from tip of nose to base of ribs. The tip of the tube should be lubricated and gently introduced; taking care to avoid the trachea (the chances of the tube entering the lungs instead of the stomach can be minimized by using a tube with a diameter larger than the trachea). Check the position of the tube (listen for gastric sounds, sniff for gastric contents, check for lack of expired air at the tip of the tube as the animal breathes) prior to administering any fluids; if in doubt, remove the tube and replace it carefully.

Animals that are chemically immobilized for intake procedures or are weak and obtunded should not be given oral fluids. Subcutaneous fluids (e.g., lactated Ringer's solution), may be administered instead at 20-40 ml/kg. If ingestion of oil is suspected, a ToxiBan slurry (6ml/kg) can be administered via a stomach tube just prior to anesthetic reversal (Williams and Sawyer, 1995). Extreme care must be taken to prevent gastric reflux and aspiration during this procedure. The risks associated with passing a stomach tube must be weighed against the risks associated with continued exposure to ingested petroleum. The Wildlife Veterinarian will determine which treatment option is best.

Severely depressed animals may require intravenous fluid administration and may require other medication in addition to isotonic fluids. Additional fluid therapy (maintenance fluids plus correction of fluid deficits) will be determined by the attending veterinarian, based on an evaluation of blood work, concurrent fluid losses, and continuing assessment of the animal's condition. The fluid deficit is calculated by multiplying an animal's mass in kg x 1000 ml fluid/kg x the percent dehydration (e.g., 5% = .05). This should be added to the animal's daily maintenance fluid requirement (at least 40 ml/kg/day) and administered within the first 24 hr if possible.

Monitoring: Animals should be regularly monitored during the rehabilitation process. Clinical observations, feeding observations (food consumption and/or preferences), and behavior should be written on the medical records. Body weight should also be monitored repeatedly during rehabilitation and recorded, at a minimum, upon admission, pre-washing, and prior to release. More extensive body weight monitoring may be required in critical cases. Physical examinations should be performed upon admission, prior to washing, and prior to release with all information recorded on individual medical records. Whenever medications are administered, the name of the

drug, dose and route (oral, SQ, IM, or IV) should be recorded as well as the initials of the person who administered the medication (Appendix 12, Treatment Information and Orders). Complete medical records are important for determining release ability and are viewed as potential evidence by the law and should be carefully and completely filled out by animal caretakers.

Monitor during rehabilitation and record in medical records:

- Clinical observations
- Body weight
- Food consumption
- Behavior
- Medications

Appendix 4

Wash/Rinse Procedures

(Extracted and modified from OWCN Protocols for the Care of Oil-Affected Marine Mammals 5-07 page 37-40) Sea otters have the densest fur of any mammal, and unlike most other marine mammals replace their fur throughout the year instead of undergoing a seasonal molt (Tarasoff, 1974; Williams and Allen et al., 1995). Otters have guard hairs and many fine under hairs that are microscopically interlocked in order to trap air thus providing waterproofing, thermal insulation, and buoyancy. Oil contamination causes fur clumping which leads to a loss of insulation and predisposes otters to hypothermia from the cold ocean water.

General Guidelines for Washing Sea Otters:

1. Anesthesia/sedation
2. Diluted Dawn solution
3. Temperature controlled warm water
4. Pressurized rinse (40-60 minutes)
5. Dry with towels and blow dryers
6. Anesthesia reversal

Anesthesia: Due to their aggressive temperament, sea otters generally require sedation or anesthesia to be washed. A variety of anesthetics have been used, however, the current preferred drug combination in adult sea otters for nonsurgical procedures is 10 mg/ml fentanyl administered at 0.22 mg/kg and 5 mg/ml midazolam (0.07 mg/kg) used together intramuscularly (Murray 2007). The opioid antagonist naltrexone at 0.44 mg/kg is recommended for reversal, but often three to four times the total dose of fentanyl administered can be needed for complete reversal (Monson et al., 2001). While sedated, supplemental oxygen is sometimes provided either via facemask, or, if the sea otter is sedate enough to tolerate it, via endotracheal tube or breathing and heart rate are monitored closely throughout the procedure. During sedation and cleaning, the core temperature of the sea otter must be monitored continuously because otters can become hypothermic or hyperthermic very quickly. Whenever a sea otter is sedated, bags of crushed ice should be readily available and placed under the animal's neck and flippers if hyperthermia occurs.

Washing and Rinsing: Sea otters are washed with multiple applications of diluted (5%) Dawn dishwashing detergent. Ideally, washing tables will be equipped with three or four well-aerated nozzles dispensing temperature controlled (28-37 °C, 80-98 °F), softened (3-5 gr.) fresh water. The water temperature affects the body temperature and needs to be adjusted according to the otter's body temperature to prevent hyper or hypothermia (Davis and Hunter, 1995; Stoskopf et al., 1997). Four to six people are required per washing table, one (with heavy gloves) specifically to hold the head and forearms. The detergent is gently massaged into the oiled fur and then rinsed off under moderate pressure (30-40 psi) with a spray nozzle. Washing will consist of a wash, rinse, wash, rinse cycle until there is no indication of oil in the rinse water and no petroleum odor on the fur. Depending on the degree of oiling, washing will usually take from 40-60 minutes. A final rinse with a spray nozzle lasting an additional 40 minutes to one hour is essential to thoroughly remove the detergent and restore the furs' water repellency. Dilute Dawn solution (5%) = 0.8 cups detergent per 1 gal water (6.4 oz / 1 gal).

Animals would be washed in the trailer and then transferred to critical care cages. These cages do not have pools. The critical care cages can be constructed with a wood frame covered with four inch stretch mesh net. Approximate dimensions are 40 inches long, 25 inches wide and 25 inches tall and they would be equipped with a sliding lid and slotted bottom. When released from the critical care cages by the attending DVM or Veterinary Technician they will be transferred to a holding area. Tanks or specially constructed pens designed for two adult sea otters can serve as the holding area. The two otter pens are equipped with doors covered with 4 inch stretch mesh net and allow water to be circulated in and out of a pool area located in the pen. Details of cage designs are available in “Emergency Care and Rehabilitation of Sea Otters” by Terrie Williams and Randall Davis (1995) and “Advances in Rehabilitating Oiled Sea Otters: The Valdez Experience” by Randall Davis (1990).

Appendix 5

Guidelines for Formula Diets and Hand Rearing of Sea Otters

Version I: Formula and Preparation

Clams, finely chopped 120 g
Squid, remove beak, quill and ink sac 120 g
Dextrose 5% in water 100 ml
Lactated Ringers solution 100 ml
Whole milk/whipping cream 50/50 200 ml
Multivitamin supplement w/iron (Hi-Vite) 2 ml
Dicalcium phosphate 500 mg
Cod liver oil 2 ml

Chop squid and clams into fine pieces and then puree (do not whip). Add liquids and vitamins/minerals to puree and mix well. Blend in dairy products last. Treat the dairy blend with Lactaid® (McNeil Consumer Healthcare, Ft. Washington, PA) and/or lactobacillus to aid in milk digestion if diarrhea occurs. Add All-Bran® (Kellogg's, Battle Creek, MI) cereal (5 g to formula batch above) for fiber, if stools are chronically soft. Mix enough formula for 24 hours, label with time and date of preparation and refrigerate. Discard unused portion after 24 hours or immediately freeze individual portions and label time and date, thaw/warm and use as needed. Discard unused frozen portions after one week.

Version II: Monterey Bay Aquarium Formula and Preparation

Zoologic Milk Matrix 30/55 120 g
Zoologic Milk Matrix 33/40 40 g
Water 480 g

Use blender to prepare formula. Add water to blender first, and then dry ingredients. Blend on “high” for 30 seconds; scrape dry powder off sides of blender canister with spatula, then blend an additional 30 seconds on “low”. Do not over-mix formula. Refrigerated shelf-life of reconstituted formula is 24 hrs.

This formula yields:

Protein 8.34%
Fat 13.3%
Carbohydrate 1.06%
Moisture 76.0%
Ash 1.3%
Kcal/100 gm 157

NOTE: It is recommended that infant sea otter pups receive supplemental parenteral (subcutaneous) isotonic fluids at 3-5% body weight per day while on this formula. The fluids may be discontinued when the fluid content of the solid foods consumed meets the volume of parenteral fluids delivered daily.

Delivery Methods and Techniques

Very young sea otter pups seem to adapt to nursing a bottle readily. Older pups may not have a strong enough suckle urge and may need to be tube-fed until weaned onto solids. If pups will nurse on a bottle use an infant latex nurser bottle with disposable bags (4 oz size for newborns up to 4 kg (9 lb) body weight, and then the 8 oz size), plus a standard infant nipple with an "X"-cut opening at the nipple aperture to accommodate the thicker formula. Feed formula to the pup (face down, lying on its belly) and push the formula through the nipple by applying pressure to the nurser bag with a home-made "syringe plunger" allowing delivery of formula more rapidly as the pup nurses and/or sucks food from the nipple. Pups like the nipple pushed up through a hole in a clean terry washcloth. If feeding via gavage is necessary, use a red rubber urethral catheter, 12-14 french, 16" long and a 60 ml catheter-tip syringe.

Feeding Frequency and Daily Requirements

Because sea otters have a high metabolic rate, they require a food intake equal to 20-35% of their body weight daily. Initially, their daily formula I intake should equal 30% of their body weight divided into 8-10 feedings for the first 1-3 weeks of age. At this point, gradually increase the amount of formula offered at each feeding and decrease the feeding frequency to 4-6 feedings per day. With formula II, feed at a volume of 15-20% of body weight per day divided into 4-6 feedings.

Adjust total daily formula amount based on the rate of weight gain. Weigh pups at the same time each day, preferably in the morning prior to the first feeding. Expect an average weight gain of approximately 1% body weight per day. The weight may plateau every 2-5 days. Loss of more than 5% body weight at any time, or loss of weight over two consecutive days may be because too little formula is being offered, or may indicate a medical problem.

Weaning procedures

At 3-4 weeks of age, offer small soft pieces of clam, squid, peeled shrimp, or other seafood before offering formula. Record total weight of solid food consumed. At 6 weeks of age or when the pup is taking soft bits readily, open shells and loosen the muscle of whole clams or mussels. At 8-10 weeks start to offer unpeeled shrimp and whole crab legs, and then intact mussels by 12-16 weeks of age.

Gradually decrease formula feedings equal to the measured amount of voluntary solid food intake. Most pups are weaned to an exclusively solid diet by 4 months of age. Continue to weigh each pup frequently and supplement with formula if weight loss occurs, or if the pup fails to gain weight.

Appendix 6.
Weight and Length Ranges for Sea Otters

Class	Weight	Length	Age
Pup	1.6 - 8.2 kg	50 - 85 <i>cm</i>	0 - 3 months
Pup, immature	5.1 - 15.4 kg	76 - 106 cm	3 m - 1yr
Subadult	10.1 - 22.9 kg	96 - 118 cm	1 - 4 yrs
Adult female	16 - 32 kg	110 - 130 cm	> 4 yrs
Adult male	17.6 - 48 kg	110 - 150 cm	> 5 yrs

Ames, J., personal communication, California Department of Fish and Game, Santa Cruz, CA, 2003.

--This page intentionally left blank--

Appendix 7: Forms

--This page intentionally left blank--

Oiled Marine Mammal Search Effort Log (SEL)

Oil Spill Name:				Date:		Searchers:					
Beach Search Number	Search Location (Beach Name) and Segment Number	Start Time	End Time	North/West Extreme GPS Coordinate (Lat.) N	North/West Extreme GPS Coordinate (long.) W	South/East Extreme GPS Coordinate (Lat.) N	South/East GPS Coordinate (Long.) W	Estimated length of segment searched	Number of live oiled animals	Number of dead animals	Position Report Numbers

Oiled Marine Mammal Position Report

Oil Spill Name:				Position Report Number:						
Location (Beach Name)	SEL Beach Search #	Beach Segment #	Species	Number live and oiled	Number Dead	GPS Coordinate (Lat.) N	GPS Coordinate (Long.) W	Date Observed (M/D/Y)	Time Observed (24 hr)	Notes

Oiled Marine Mammal Data Log: Live Animals

Oil Spill Name:			Facility:								
Intake Log Number	Date Collected (M/D/Y)	Time Collected (24 hr)	First Initial & Last Name of Collector	Search Effort Log Beach Number	Collection Location (Beach Name)	GPS Coordinate N	GPS Coordinate W	Field Tag #	Date Arrived (M/D/Y)	Time Arrived (24 hr)	

Oiled Marine Mammal Data Log: Live Animals

Oiled Marine Mammal Data Log: Live Animals

Oil Spill Name:			Facility:											
Intake Log Number	Date Processed (M/D/Y)	Time Processed (24 hr)	First Initial & Last Name of Examiner	Species	Level A Field #	Tag Color & #	% Oiled	Photo taken: (Y:N)	Disposition Date (M/D/Y)	Disposition Status (R,D,E,T)	Release Tag #	Morgue ID		

Oiled Marine Mammal Data Log: Dead Animals

Oil Spill Name:				Facility:												
Intake Log Number	Date Collected (M/D/Y)	Time Collected (24 hr)	First Initial & Last Name of Examiner	SEL		Collection		GPS Coordinate N	GPS Coordinate W	Tag #	Date Arrived		Date Processed		Name of Processor	Species
				Beach Search #	Location (Beach Name)	Arrived (M/D/Y)	Arrived (24 hr)				Processed (M/D/Y)	Processed (24 hr)				

Front Side of Page _____ of _____

Oiled Marine Mammal Data Log: Dead Animals

Oiled Marine Mammal Data Log: Dead Animals

Oil Spill Name:											Facility:										
Intake Log Number	Condition	Scavenging	Oiling Signs	% Oiled	Depth Oiled	Photo taken: (Y/N)	Level A Field #	Tag Color & #	Age	Sex	SL (cm)	AG (cm)	Morgue ID	Necropsy (Y/N)	Notes						

Back Side of Page ____ of ____

Oiled Marine Mammal Intake Form												
Spill Name					Level A Field #		Log Number					
Capture	Capture Date/Time:				Capture Location:							
	Field Band:				Collector:							
Processing	Intake Date/Time:				Species:							
	Tag Color/#.				Examiner's Signature							
EXT OIL ID	Signs of Oiling	Oiled Visible		Skin Burns		Small		Area Oiled	Head	Body	Multiple	Entire
	Oil Color	Black	Brown	Clear	Other		Depth of Oiling	Deep	Moderate	Sever		
	% Oiled	<2%	2-25%	26-50%	51-75%	76-100%		Samples	Hair	Swab	Photo	
Physical Exam	Weight/Temp	Grams			F		Age	Pup	Sub-adult	Adult	Unknown	
	Std Length/Girth	cm			cm		Sex	Male		Female		
	Heart Rate	WNL		beats/min.			Body Condition	Normal		Thin	Emaciated	
	Resp. Rate	WNL		breaths/min.			Attitude	BAR	QAR	Nonresponsive		Seizing
	Dehydration	None	mild	moderate	severe		CRT/MM COLOR	Sec./Pink	Pale	White	Purple	
	Human Interaction	Yes__ No__ Type: Boat Collision, shot Fisheries, Other										
	Neurologic	NSF: Other:										
	Head/Mouth	NSF: Other:										
	Eyes/Ears	NSF: Other:										
	Heart/Lungs	NSF: Other:										
Gastrointestinal	NSF: Other:											
Musculo-skeletal	NSF: Other:											
Integument	NSF: Other:											
Comments:												
TX-DX	Blood Taken? HCT LTT RTT GTT Toxiban: Yes__ No__ Time:											
	Pre-wash Exam:			Date Washed:			Weight:			Bloodwork Attached__		
Disposition	Disposition Exam:			Exam Date:			Weight:			Bloodwork Attached__		
	Disposition Date:			Disposition Location								
	Disposition Status: RELEASED DIED EUTHANIZED TRANSFERED RETAINED Necropsied by:											
	Flipper Tag No.			Location RF LF RH LH								

TAG # _____

SPECIES: _____

--This page intentionally left blank--

Oiled Marine Mammal Daily Progress Form

Spill Name:		Log #:	Tag Color:	Species:
Date (M/D/Y)	Treatment and Progress Notes			Initials

--This page intentionally left blank--

Appendix 8

Oiled Marine Mammal Evidence Collection Protocol

The photograph and oil sample are both considered to be legal evidence therefore it is important that the following procedures are followed closely.

Photograph Evidence:

1. Use a digital camera.
2. Photograph should include the entire animal, highlighting the oiled region, and if possible, the tag number.
3. Label the photograph with Spill Name, Date, Species, Intake Log Number, Capture Location, and Tag Number & Color.

Sample Collection Techniques for Visible Oiling:

1. Scrap visible oil from fur with wooden spatula (tongue depressor).
2. Insert oil covered spatula in designated glass jar and break off the remaining un-oiled portion, allowing the lid to close.
3. Note: Do not allow the nitrile gloves to touch the oil sample
4. Label the glass jar (use the waterproof labels provided in the kit). Label must include: Spill Name, Died/Euthanized, Log #, Species, Tag, Arrival Date, Death Date, and Capture Location.
5. Fill out the Evidence Tape then apply across the lid of the jar and onto the sides of the glass.
6. Keep sample refrigerated.

Sample Collection Techniques for No Visible Oiling:

Step A:

1. Rub an affected area with a 4x4 cotton cloth with sterile forceps or hemostats that have been cleaned with isopropyl alcohol.
2. Note: Do not allow the nitrile gloves to touch the oil being sampled nor the cloth it is collected on.
3. Place the oiled covered cloth into a designated glass jar.
4. Seal and fill out the information on the waterproof label.
5. Fill out the Evidence Tape and apply across the lid of the jar and onto the sides of the glass.
6. Keep sample refrigerated.

Step B:

1. A sample of the cloth used in Step A must be submitted to identify cross contamination.
2. Obtain another glass jar and place a piece of the same cotton cloth (4x4). It is important that the cloth is identical to the cloth used to obtain the oil sample.
3. Fill out the waterproof label. In the place of the Spill Name: State that this jar contains the cloth only. This cloth acts as a control for the oil samples submitted on cloth.

Both pieces of evidence should be securely stored and refrigerated until further instructions are provided. If samples are to be sent for analysis, a Chain of Custody Form is required.

--This page intentionally left blank--

Instructions: circle response under each category.

NSF: no significant findings, NE: not examined, NA: not applicable

HAIR COAT: NSF, NE

lanugo, partial lanugo, patchy alopecia, extensive alopecia, lice, mites, other ectoparasites, molting, loss of guard hairs

INTEGUMENT (SKIN) and PINNAE: NSF, NE

puncture wounds, lacerations, scars, NEESDz, shark bite (wound sheet attached: yes/no)
pox, vesicles, pustules – RFF, LFF, RHF, LHF

MAMMARY GLANDS AND NIPPLES: NSF, NE, NA

swelling, discharge, lactating, parasites

OCULAR DISCHARGE: NSF, NE

Right: slight, moderate, copious

Color/type: green, yellow, white, mucoid, serous

Left: slight, moderate, copious

Color/type: green, yellow, white, mucoid, serous

EYES: NSF, NE

Right: conjunctiva reddened, third eyelid redness, third eyelid prolapsed, corneal opacities, ulcers, lacerations, rupture, desmetocoel (bulge), phthisis bulbae, lens opacity

Left: conjunctiva reddened, third eyelid redness, third eyelid prolapsed, corneal opacities, ulcers, lacerations, rupture, desmetocoel (bulge), phthisis bulbae, lens opacity

NASAL DISCHARGE: NSF, NE

Right: slight, moderate, copious

Color/type: green, yellow, white, mucoid, red, clear, vomitus

Left: slight, moderate, copious

Color/type: green, yellow, white, mucoid, red, clear, vomitus

MUCOUS MEMBRANES: NSF, NE

color: pink, pale pink, red, yellow, white, purple, brown

ORAL CAVITY AND PHARYNX: NSF, NE

ulcers on tongue, ulcers on gums, ulcers on hard palate, fluid, vomitus, foreign bodies

teeth: black, brown, white,

unerupted, just erupting, missing teeth, broken teeth, worn teeth

tonsil: enlarged, red, purple, pus

NASOPHARYNX: NSF, NE

nasal mites, long type or fat type, approx. no. _____, fluid

EXTERNAL GENITALIA AND ANUS: NSF, NE

swollen perineum/scrotum/vulva, prolapsed penis, necrotic penis,

diarrhea: green, yellow, black, brown, blood

UMBILICUS: NSF, NE

open, red, purple, moist, stump, dry stump, healed, exudate present: yellow, red, green, thin, purulent

FALCIFORM LIGAMENT: NSF, NE

patent, closed, pus filled

BLUBBER: NSF, NE

color: white, yellow, pink, red, brown

edema, focal hemorrhage, extensive hemorrhage, cysts, abscesses, necrotic fat, parasites

SKELETON AND JOINTS: NSF, NE

fractures: open, closed, simple, compound, comminuted, compression, dislocations, osteomyelitis, tumors, deformities, callus, periosteal reaction

lesion locations:

MUSCULATURE: NSF, NE

pale, abscesses, hematomas, congested, necrosis, parasites, other lesions describe:

SALIVARY GLANDS: NSF, NE

describe abnormalities:

THYROID: NSF, NE

describe abnormalities:

SUBMANDIBULAR LN: NSF, NE

Right: hemorrhagic, abscessed, gelatinous, serous fluid, soft, hard; slightly, moderately, severely enlarged

Left: hemorrhagic, abscessed, gelatinous, serous fluid, soft, hard; slightly, moderately, severely enlarged

RETROPHARYNGEAL LN: NSF, NE

Right: hemorrhagic, abscessed, gelatinous, serous fluid, soft, hard; slightly, moderately, severely enlarged

Left: hemorrhagic, abscessed, gelatinous, serous fluid, soft, hard; slightly, moderately, severely enlarged

AXILLARY LN: NSF, NE

Right: hemorrhagic, abscessed, gelatinous, serous fluid, soft, hard; slightly, moderately, severely enlarged

Left: hemorrhagic, abscessed, gelatinous, serous fluid, soft, hard; slightly, moderately, severely enlarged

PLEURAL CAVITY: NSF, NE

fluid: approx. _____ ml, purulent, serous, fibrinous, yellow, white, green, blood tinged, frank blood.

adhesions, plaques

ESOPHAGUS: NSF, NE

dilated, constricted, perforated, ulcerated, mucosa hemorrhagic, foreign bodies, fluid filled, obstructed, diphtheritic membrane

MEDIASTINAL LN: NSF, NE

hemorrhagic, abscessed, serous fluid, soft, hard, slightly enlarged, moderately enlarged, severely abscessed, gelly, enlarged

LARYNX: NSF, NE

describe lesions:

TRACHEA: NSF, NE

punctures, lacerations, foam, mucoid, purulent, white, yellow, red, green, blood

mucosa: congestion, hemorrhagic, ulcer

parasites: mites, Parafilaroides,

Otostrongylus – approx. # and length: _____

BRONCHI: NSF, NE

punctures, lacerations, foam, mucoid, purulent, white, yellow, red, green, blood

mucosa: congestion, hemorrhagic, ulcer

parasites: mites, Parafilaroides, Otostrongylus – approx. # and length: _____

LUNGS:

Parafilaroides 1+ 2+ 3+ 4+, none detected

Right: NSF, NE

color: pink, red, purple, mottled

interstitial edema: severe, moderate, mild

congested, atelectic, consolidated, abscesses, granulomas, emphysema, metastases

lesion locations: cranial, caudal, dorsal, ventral, middle

lesion distribution: diffuse, focal, multifocal, miliary

severity: severe, moderate, mild, slight

describe lesions:

Left: NSF, NE

color: pink, red, purple, mottled

interstitial edema: severe, moderate, mild

congested, atelectic, consolidated, abscesses, granulomas, emphysema, metastases

lesion locations: cranial, caudal, dorsal, ventral, middle

lesion distribution: diffuse, focal, multifocal, miliary

severity: severe, moderate, mild, slight

describe lesions:

PULMONARY ARTERIES AND AORTA: NSF, NE

thrombi, plaques, rupture, parasites, *Otostrongylus*, other heartworm: number:____, size:____cm

DUCTUS ARTERIOSUS: NSF, NE

wide open, partially closed, sealed

PERICARDIUM: NSF, NE

thickened, plaques on surface, contains fluid

describe fluid:

HEART AND VALVES: NSF, NE

Right ventricle: NSF, NE, thickened, dilated (thickness mm:____)

Left ventricle: NSF, NE, thickened, dilated (thickness mm:____)

Atria and auricles: NSF, NE, foramen ovale sealed, not sealed, open

Myocardium: NSF, NE, pale, dark, tumors abscess, white foci

Epicardium and valves: NSF, NE, plaques

lesions and parasite locations, describe:

THYMUS: NSF, NE atrophy, enlarged**ABDOMINAL CAVITY: NSF, NE**

FLUID : none, approx _____ml, yellow, green, brown, blood tinged, clear, chunky, ingesta, frank blood, tenacious; Odorous? yes/no, uremic, worms

PERITONEUM, OMENTUM AND MESENTERY: NSF, NE

tumors, granulomas, abscesses, adhesions congested, hematomas, parasites

GALL BLADDER, BILE DUCT, PANCREATICODUODENAL DUCT: NSF, NE

full, empty, thickened wall, thin wall, flukes

bile: thick, thin, black, dark green, light green yellow, orange, calculi

LIVER: NSF, NE

enlarged, small, cirrhotic, fatty infiltration, ruptured, lacerated, parasites

congestion: mild, moderate, severe

color: normal, dark, pale, mottled, yellow, orange, nutmeg pattern

lesions: abscesses, granulomas, masses, cysts, fibrin tags, hemorrhages

distribution of lesions: diffuse, focal, multifocal, miliary, pinpoint

degree of severity: slight, mild, moderate, severe

if friable: mildly, moderately, severely

elaborate:

SPLEEN: NSF, NE

masses, slightly enlarged, severely enlarged, constricted, congested, abscesses, scars, pale, purple, brown, red

PANCREAS: NSF, NE

loss of lobulation, hemorrhage, abscesses, swollen

color: white, pink, other _____

STOMACH: NSF, NE

loss of rugae, swollen rugae, thickened, volvulus, perforated ulcer

mucosa: white, pale pink, red, purple, other _____

erosions or ulcers: mild, moderate, severe, volcanic, pinpoint

ascarids: 1+ (<10) 2+ (10-20) 3+ (20-50) 4+ (>50)

contents: empty, dilated with gas, mucus, formula, fluid, fish, crustaceans,

cephalopods, foreign bodies, sand, rocks, undigested, partially digested, digested

INTESTINES: NSF, NE

tape worms 1+ 2+ 3+ 4+, empty, bile, digesta, parasites, other lesions:

color: normal, autolyzed (green), congested, purple, black, red, yellow, white

CECUM: NSF, NE

empty, digesta, parasites, other lesions:

color: normal, autolyzed (green), congested, purple, black, red, yellow, white

COLON: NSF, NE

feces: normal (firm), empty, thin, dry, tarry, meconium

color: normal, autolyzed (green), congested, purple, black, red, yellow, white

MESENTERIC LN: NSF, NE

hemorrhagic, grey, chylous, abscessed, gelatinous, serous fluid, soft; slightly, moderately, severely enlarged

INGUINAL LN: NSF, NE

Right: hemorrhagic, grey, abscessed, gelatinous, serous fluid, soft; slightly, moderately, severely enlarged

Left: hemorrhagic, grey, abscessed, gelatinous, serous fluid, soft; slightly, moderately, severely enlarged

SUBLUMBAR LN: NSF, NE

hemorrhagic, grey, abscessed, gelatinous, serous fluid, soft, tumors; slightly, moderately, severely enlarged

GASTRIC LN: NSF, NE

hemorrhagic, grey, abscessed, gelatinous, serous fluid, soft, tumors; slightly, moderately, severely enlarged

PANCREATIC LN: NSF, NE

hemorrhagic, grey, abscessed, gelatinous, serous fluid, soft, tumors, slightly enlarged, moderately enlarged, severely enlarged

ADRENAL GLANDS:

Right: NSF, NE

size: enlarged, shrunken

cortex: normal, thick, thin, dark, pale, hemorrhagic, striated

medulla: normal, dark, pale

C:M ratio:

Left: NSF, NE

size: enlarged, shrunken

cortex: normal, thick, thin, dark, pale, hemorrhagic, striated

medulla: normal, dark, pale

C:M ratio:

KIDNEYS:

Right: NSF, NE

size: slightly enlarged, severely enlarged, shrunken

cortex color: pale, dark, red, pink, tan, purple

medullae color: pale, dark, red, pink, tan, purple

lesions: congestion, hemorrhage, hematomas, abscesses, parasites,

cysts, hydronephrosis, masses, calculi, wedge emboli

loss of renule differentiation: mild, moderate, severe

Left: NSF, NE

size: slightly enlarged, severely enlarged, shrunken

cortex color: pale, dark, red, pink, tan, purple

medullae color: pale, dark, red, pink, tan, purple

lesions: congestion, hemorrhage, hematomas, abscesses, parasites,

cysts, hydronephrosis, masses, calculi, wedge emboli

loss of renule differentiation: mild, moderate, severe

URETERS:

Right: NSF, NE
dilated, tumors, abscesses, calculi (SAVE), hydroureter

Left: NSF, NE
dilated, tumors, abscesses, calculi (SAVE), hydroureter

URINARY BLADDER: NSF, NE

empty, dilated, thickened, tumors
mucosa: hemorrhagic, ulcerated, masses, ulcers, plaques, necrotic
other lesions:
urine: bloody, golden, dilute, purulent, other _____

URETHRA: NSF, NE

patent: yes/no, ulcers, calculi, strictures, tumors

GONADS:

Right: NSF, NE
enlarged, shrunken, masses, corpora lutea (#), follicles (#), tumors, cysts

Left: NSF, NE
enlarged, shrunken, masses, corpora lutea (#), follicles (#), tumors, cysts

UTERUS, CERVIX, VAGINA: NSF, NE, NA

enlarged, dilated, hemorrhagic, purulent fluid, tumors, masses, mucus, fetus,
placental scar on endometrium, plaques describe:

CSF: NSF, NE

increases amount, blood tinged

DURA MATER AN INSIDE CALVARIUM: NSF, NE

gunshot, purulent exudate, hemorrhage, congested, meninges

CEREBRUM: NSF, NE

congested, abscesses, purulent exudate, hemorrhage, asymmetry, edema

CEREBELLUM: NSF, NE

congested, abscesses, hematomas, asymmetry, edema

SPINAL CORD: NSF, NE

hematomas, congestion, purulent exudate

Appendix 10. Treatment Information and Orders

Spill name:

Animal Log Number:

start/stop	FOOD TYPE	Amount	Time
/			
/			
/			
/			
/			
/			
/			
/			
/			
/			

Data	Weight (Kg)	Wet/Dry

start/stop	SUPPLEMENTS	Amount	Time
/	Pinnivites		
/	Vitamin E		
/	NaCl		
/			

HOUSING/HUSBANDRY

start/stop	MEDICATION / FLUIDS	Dose	Route	Time
/				
/				
/				
/				
/				
/				
/				
/				

--This page intentionally left blank--

Appendix 11. Marine Mammal Blood Results

	Spill Name:	Animal Log Number:				
Date Sample Taken						
Laboratory						
Complete Blood Count						
WBC	x1000/ul					
RBC	x1000/ul					
HGB	g/dl					
HCT	%					
MCV	fl					
MCH	pg					
MCHC	g/dl					
RETICULOCYTE	count					
Differential						
NEUTROPHILE SEG	%					
	absolute					
NEUTROPHILE BANDS	%					
	absolute					
LYMPHOCYTE	%					
	absolute					
MONOCYTE	%					
	absolute					
EOSINOPHIL	%					
	absolute					
BASOPHIL	%					
	absolute					
REMARKS						
Serum Chemistry						
ALK. PHOSPHATASE	IU/L					
ALT (SGPT)	IU/L					
ASR (SGOT)	IU/L					
CK	IU/L					
GGT	IU/L					
SDH	IU/L					
LDH	IU/L					
AMYLASE	IU/L					
LIPASE	IU/L					
ALBUMIN	g/dl					
TOTAL PROTIEN	g/dl					
GLOBULIN	g/dl					
TOTAL BILIRUBIN	mg/dl					
DIRECT BILIRUBIN	mg/dl					
INDIRECT BILIRUBIN	mg/dl					
BUN	mg/dl					
CREATININE	mg/dl					
URIC ACID	mg/dl					
GLUCOSE	mg/dl					
CALCIUM	mg/dl					
PHOSPHORUS	mg/dl					
TCO2 (BICARBONATE)	mEq/L					
CHLORIDE	mEq/L					
POTASSIUM	mEq/L					
SODIUM	mEq/L					
CHOLESTEROL	mEq/L					
TRIGLYCERIDES	mEq/L					
IRON	ug/dl					
ANION GAP	mEq/L					
THYROID (T4)	ug/dl					
Other:						

--This page intentionally left blank --